



Union Special[®]
LEWIS[®] • COLUMBIA[®]

INDUSTRIAL
SEWING
MACHINES

LIST OF PARTS
FOR
STYLES IN CLASSES
80200

80600

81200

CLASSES
80200
80600
81200

CATALOG
No. 73L
Third
Edition

UNION SPECIAL CORPORATION

From the library of: Superior Sewing Machine & Supply LLC

Catalog No. 73 L

LIST OF PARTS

STYLES IN CLASSES

80200

80600

81200

Third Edition

Copyright 1947

by

Union Special Corporation

Rights Reserved in All Countries

UNION SPECIAL CORPORATION

INDUSTRIAL SEWING MACHINES

CHICAGO

Printed in U.S.A.

July, 1976

FOREWORD

The dominating idea back of Union Special is to build the best industrial sewing machines in the world.

All parts are made to precision gauges, insuring complete interchangeability.

It is our constant aim to furnish carefully prepared information that will enable the customer to secure all possible economies and advantages from the use of UNION SPECIALS. On the pages which follow will be found illustrations and descriptions of the parts for styles in Classes 80200, 80600, and 81200.

Additional catalogs containing information relative to machines, and which will be furnished on request, are listed below.

- | | |
|------------------|---|
| Catalog No. 43 G | Assembly drawing of Junior Filled Bag Closing Machine Style 20100 D, with list of parts (drawing No. 3218 Q) |
| Catalog No. 43 H | Sub-Assembly drawing of Heavy Duty Filled Bag Closing Machines in Class 20500, with list of parts (drawing No. 5090 Q) |
| Catalog No. 43 J | Assembly drawing of Fixed Base Filled Bag Closing Machine Style 20100 H, with list of parts (drawing No. 3238 Q) |
| Catalog No. 43 K | Assembly drawing of Table Type Filled Bag Closing Machine Style 21800 C, with list of parts (drawing No. 3597 Q) |
| Catalog No. 45 N | Needle Catalog |
| Form 357 | Engineering Department Adjusting Instructions. Specify the Style number of the machine for which the adjusting instructions are required. |

In all manufacturing centers will be found Union Special representatives, who will co-operate with those who desire in planning and estimating their requirements.

UNION SPECIAL CORPORATION

Engineering Department

IDENTIFICATION OF MACHINES

Each UNION SPECIAL carries a style number which is stamped in the name plate on the machine. Style numbers are classified as standard and special. Those which are standard have one or more letters suffixed, but never contain the letter "Z". Example: "80200 AA". Style numbers which contain the letter "Z" are special. When only minor changes are made in a standard machine a "Z" is suffixed to the respective standard style number. Example: "80200 AAZ".

Styles of machines similar in construction are grouped under a class number which differs from the style numbers in that it contains no suffixed letters. Example: "80200".

STYLES OF MACHINES IN CLASS 80200

"Antaeus" Enclosed Type, High Speed Flat Bed Machines, for Heavy Duty Work

- 80200 AA For seaming heavy weight bags; one needle double locked stitch Type 401, stitch range 2 to 4 per inch, standard length 3 per inch, Type 1975 G needle, maximum thickness that can be sewed, 3/4 inch.
- 80200 AB For seaming heavy weight bags; one needle chain stitch Type 101, stitch range 2 to 4 per inch, standard length 3 per inch, Type 1975 G needle, maximum thickness that can be sewed, 3/4 inch.
- 80200 AC For seaming heavy weight bags; one needle double locked stitch Type 401, stitch range 2 to 4 per inch, standard length 3 per inch, flexible hemming attachment No. 897, Type 1975 G needle, maximum thickness that can be sewed, 3/4 inch.
- 80200 Z A special style, similar to the standard style in Class 80200 but differing in some of its component parts.

STYLES OF MACHINES IN CLASS 80600

Sewing Heads for Filled Bag Closing Machines

- 80600 E Sewing Head, for closing paper bags; filter cord guided under presser foot, double locked stitch Type 401, needle Type 1975 G, stitch range 3 to 4 per inch, standard length 3 1/2 per inch.
- 80600 F Same as 80600 E, except it makes chain stitch Type 101.
- 80600 H Sewing Head, for tape bound closure on filled multi-wall paper bags using UNION SPECIAL tape bound closing attachment and automatic tape cutter, filter cord guided under the presser foot, seam Type BSa-1, double locked stitch Type 401, needle Type 1975 G, stitch range 3 to 4 per inch, standard length 3 1/4 per inch.
- 80600 J-115 Same as 80600 AC, except standard equipment includes a friction drive pulley, suspended support, cable and associated parts, 1/4 H.P., friction drive electric motor, D.C., 115 volts, 3450 R.P.M., which develops 1400 R.P.M. on sewing head.

STYLES OF MACHINES IN CLASS 80600 (Cont'd.)

- 80600 J-161 A. C., single phase, 60 cycle, 110 volts.
80600 J-162 A. C., single phase, 60 cycle, 220 volts.
80600 J-230 D. C., 230 volts.
80600 J-362 A. C., 3 phase, 60 cycle, 220 volts.
80600 M-115 Same as 80600 AC, except standard equipment includes a Top Lock Balancer Unit, cable, friction drive pulley, and 1/4 H.P., friction drive electric motor, D. C., 115 volts, 3450 R.P.M., which develops 1400 R.P.M. on sewing head.
80600 M-161 A. C., single phase, 60 cycle, 110 volts.
80600 M-162 A. C., single phase, 60 cycle, 220 volts.
80600 M-230 D. C., 230 volts.
80600 M-362 A. C., 3 phase, 60 cycle, 220 volts.
80600 N-161 Same as 80600 E, except standard equipment includes a suspended support, cable and associated parts, filter cord accessories, 1/3 H.P., open type, friction drive electric motor and corresponding switch, 115 volts, 3450 R. P. M. which develops 1400 R. P. M. on sewing head, A. C., single phase, 60 cycle, 115 volts.
80600 N-162 A. C., single phase, 60 cycle, 220 volts.
80600 N-362 A. C., 3 phase, 60 cycle, 220 volts.
80600 P-152 Same as 80600 E, except standard equipment includes a Top Lock Balancer Unit, cable, filter cord accessories, and 1/3 H.P., open type, friction drive electric motor and corresponding switch, 115 volts, 3450 R. P. M., which develops 1400 R.P.M. on sewing head, A. C., single phase, 50 cycle, 220 volts.
80600 P-161 A. C., single phase, 60 cycle, 110 volts.
80600 P-162 A. C., single phase, 60 cycle, 220 volts.
80600 P-352 A. C., 3 phase, 50 cycle, 220 volts.
80600 P-362 A. C., 3 phase, 60 cycle, 220 volts.
80600 AC Sewing Head, for closing bags made from heavy weight fabrics; double locked stitch Type 401, needle Type 1975, stitch range 3 to 4 per inch, standard length 3 per inch.
80600 AD Same as 80600 AC, except it makes chain stitch Type 101.
80600 Z A special style, similar to the standard styles in Class 80600 but differing in some of its component parts.

STYLES OF MACHINES IN CLASS 81200

"Herakles" Enclosed Type High Speed Flat Bed Overedge Machines, for Heavy Duty Work

- 81200 A For overseaming bags made from heavy weight fabrics; one needle, two thread stitch, seam spec. 502 SSa-1, standard width of seam 3/8 inch, length of stitch ranges from 2 to 4 per inch, standard length 3 per inch, Type 1970 G needle, maximum thickness that can be sewed, 5/8 inch.
81200 H For overedging with decorative tape, rug and carpet cushions; one needle, two thread stitch, seam spec. 502 EFd-1, standard width of seam 3/8 inch, length of stitch ranges from 2 to 4 per inch, standard length 3 per inch, Type 1970 G needle.
81200 Z A special style, similar to the standard styles in Class 81200 but differing in some of its component parts.

NEEDLES

TYPE NUMBERS AND SIZES

Each needle has a type number and size number. The former denotes the kind of shank, point, length, groove, finish, and other details. The latter denotes the largest diameter of the blade, measured in thousandths of an inch midway between the shank and eye, and is stamped in the needle shank. Collectively the type and size number is the complete symbol.

To have orders promptly and accurately filled, the empty package, a sample needle, or the type and size numbers should be given. Use description on label. A complete order would read: "100 Needles, Type 1975 G, Size 250/100".

The type numbers of the needles most commonly used in the styles of machines covered by this catalog are listed below. Set opposite each type number is the description of the needle and sizes available.

<u>Type No.</u>	<u>Description</u>
1970 G	Round shank, square point, Herakles, double groove, spotted, chromium finish - sizes 200/080, 230/090, 250/100, 300/120, 400/156, 440/172.
1975 G	Round shank, square point, long Antaeus, double groove, spotted, chromium plated - sizes 200/080, 230/090, 250/100, 300/120, 350/140, 400/156, 480/188.
9844	Round shank, square point, Herakles, double groove, flat blade, 7/16 inch length of point (11 mm) plain finish - sizes 054, 060, 090, 100.
9845	Round shank, square point, Antaeus, double groove, spotted, flat blade, 7/16 inch length of point (11 mm) plain finish - sizes 054, 060, 067, 080, 090, 120, 156.

ORDERING REPAIR PARTS

LIST OF PARTS

The description of each part and its principal uses will be found in the list of parts. Always check the symbol against its description before ordering. It is not necessary to furnish the plate number.

ORDERING REPAIR PARTS

LIST OF PARTS (Cont'd.)

When a part is used, or can be used, in all machines covered by this catalog, no specific use is mentioned in the description.

For convenience in ordering, minor parts such as screws, nuts and similar articles are repeated after major parts.

(-) A dash in the "plate number" column of the list of parts indicates the absence of an illustration.

(‡) A double dagger in the "symbol to order by" column indicates that the component parts cannot be furnished separately.

IDENTIFYING PARTS

Where the construction permits, each part is stamped with its part number. Some of the smaller parts are stamped with an identification letter to distinguish them from parts similar in appearance.

All part numbers represent the same part, regardless of the catalog in which they appear.

SUPPLIES

All supplies, including taps, reamers, belting, belt hooks, belt fasteners, screwdrivers, wrenches and powdered oil stone will be promptly furnished.

USE GENUINE NEEDLES AND REPAIR PARTS

Success in the operation of these machines can be secured only with genuine UNION SPECIAL Needles and Repair Parts as furnished by the Union Special Corporation, its subsidiaries and authorized distributors. They are designed according to the most approved scientific principles, and are made with utmost precision. Maximum efficiency and durability are assured.

Genuine needles are packaged with labels marked *Union Special*. Genuine repair parts are stamped with the Union Special trademark, U S Emblem. Each trademark is your guarantee of the highest quality in materials and workmanship.

TERMS

Prices are net cash and subject to change without notice. All shipments are forwarded f.o.b. shipping point. Parcel Post shipments are insured unless otherwise directed. A charge is made to cover postage and insurance.

Plate No. 1 - Full Size

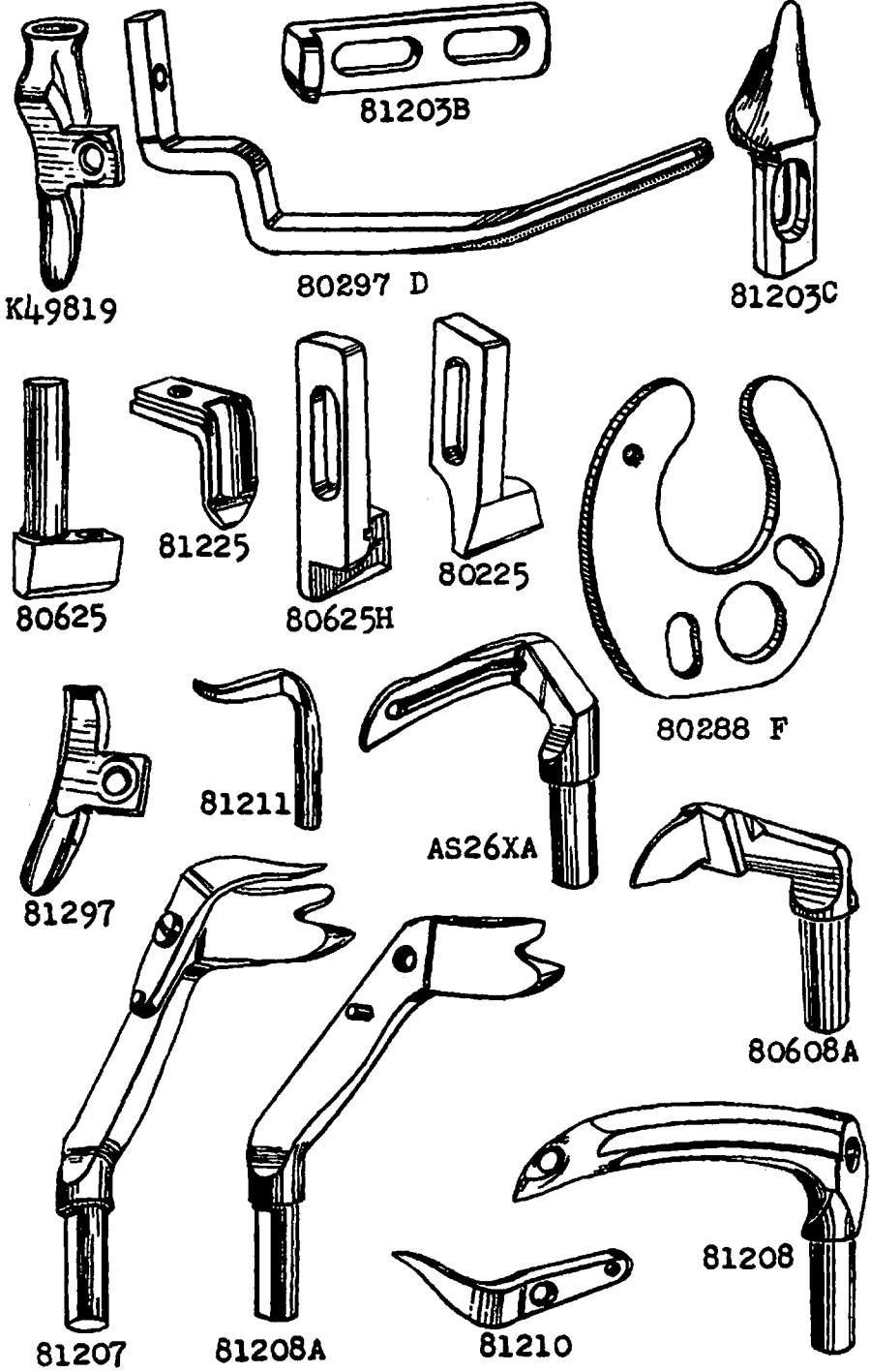
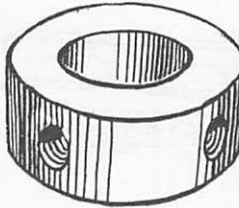

Plate No. 2 - Full Size



80681



23451 F

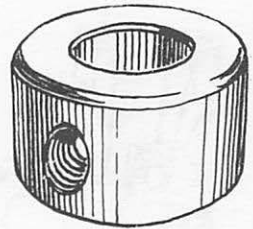

21171 N



HA1348



21111



80289



41046 G



HA1349



81093



666-90



80689 A



80690 A



HA102 A

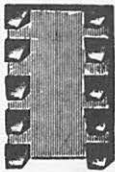

21350



HA58 C



HA58 D



80669

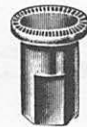

107



80668

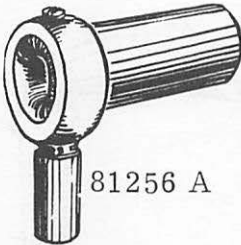

81256 A



HA103 B



80250 B



81253



80676



AS137 A



AS137



81256



81252

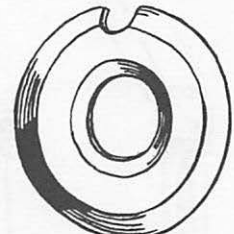

80676 A

Plate No. 3 - Full Size



Plate No. 4 - Full Size

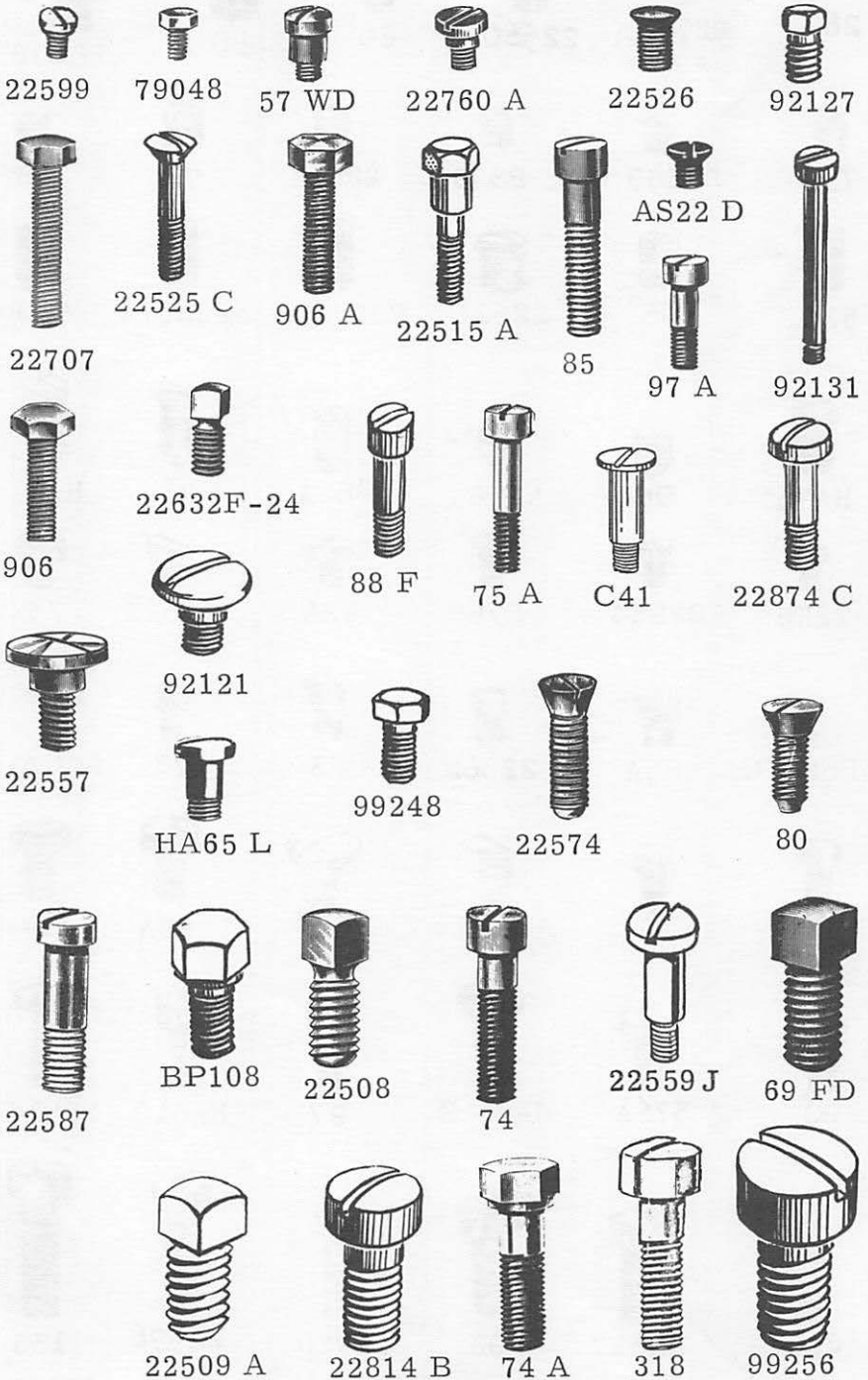

Plate No. 5 - Full Size

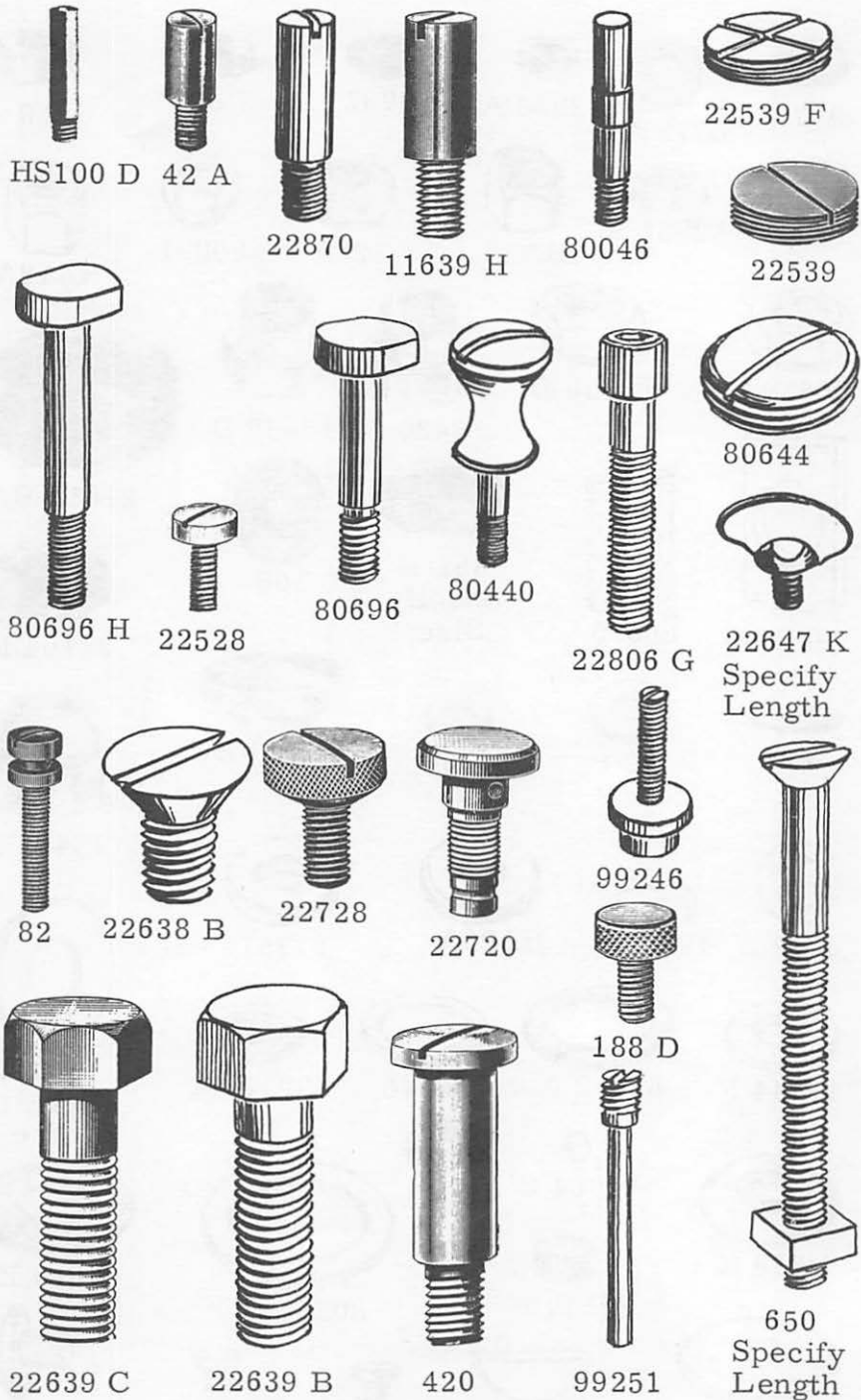

Plate No. 6 - Full Size



Plate No. 7 - Full Size



80692 B



80692 C



80292 A



80239 D

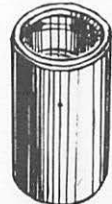

80639 D



80239 C



80662



80639 C



80673 B

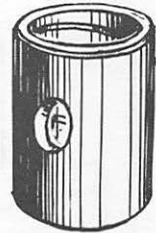

81240 C

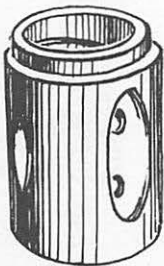

80646



80246

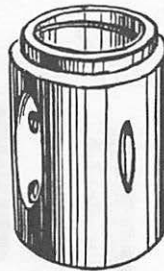

80647

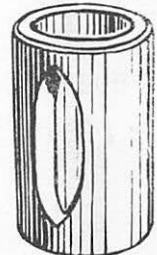

80694 B



80673 A



80662 A

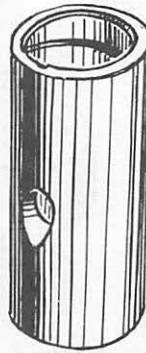

80640 D

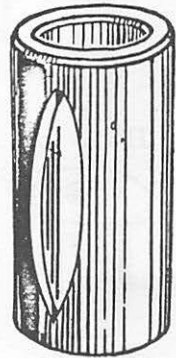

80694 C

Plate No. 8 - Full Size

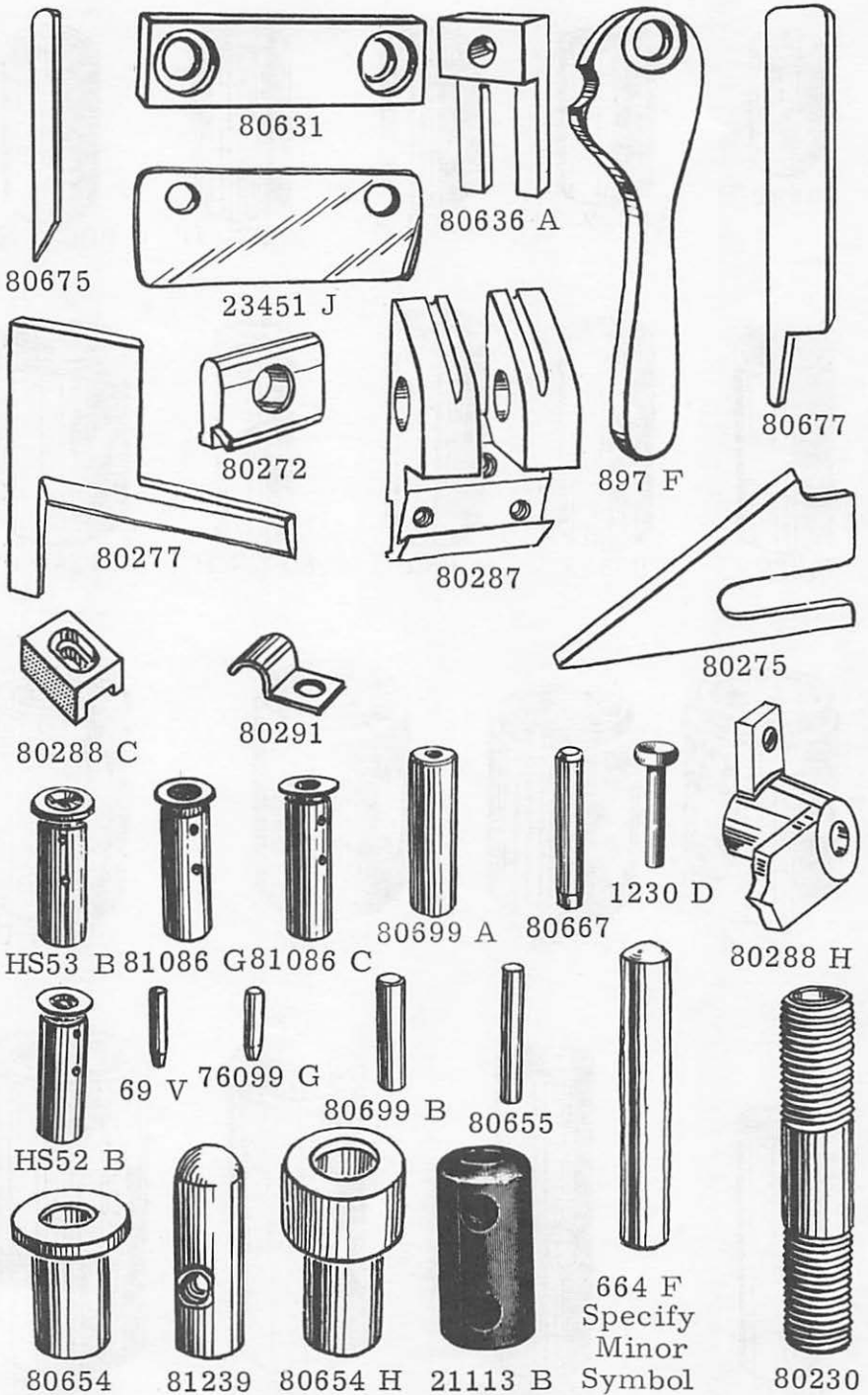
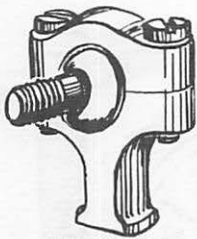
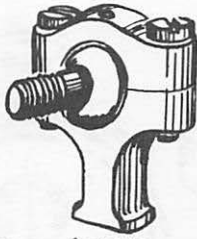

Plate No. 9 - Full Size



80657A



6038K

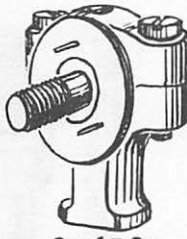

80658A

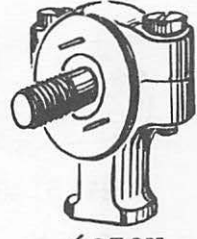

6039K



10349



80656



80645



G21710

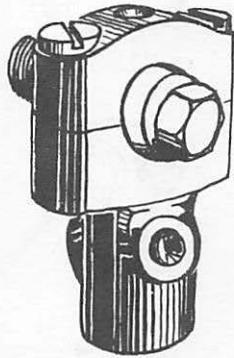

G29139A



11354

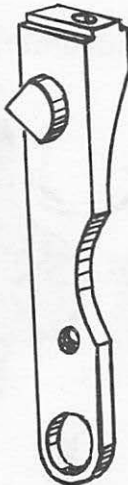

80288 B

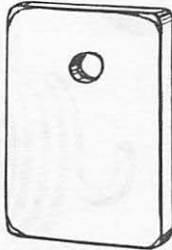

80680B



K57188



80269

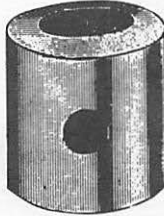

AS38B

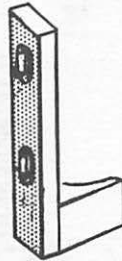

80288 A



15745B

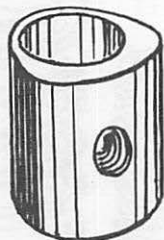

80606 B

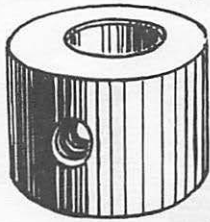

HS15A

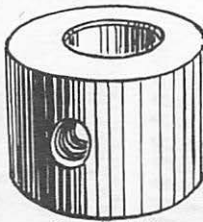

80695A

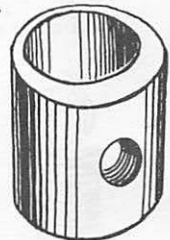

HA43X

Plate No. 10 - Full Size

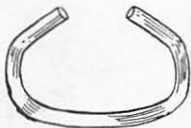

21351 A



21351



81292



HS106

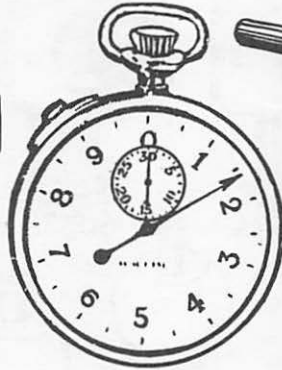

WA15 A

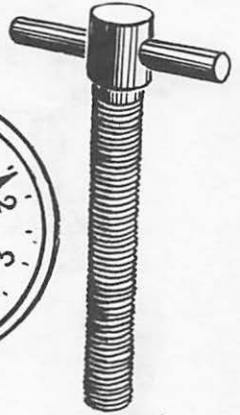

64 Y



80238

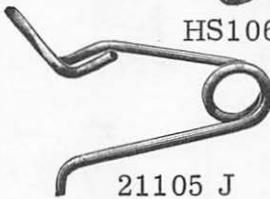

21105 J



21225
Specify
Measurement



HA1286 B



HA58 F



1286 B



80288 D

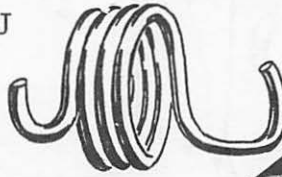

80237



21217 A



1349 A-5

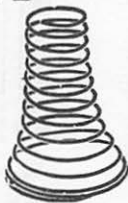

1349 A-3

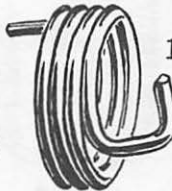

80649



1230 B



80288 G



897 E



110-2



110-3



110-4



80438



HS110



21171 P

Plate No. 11 - One-Half Size



81220C

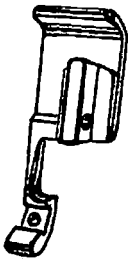

81220B

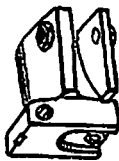

80627K

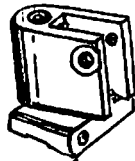

80620S

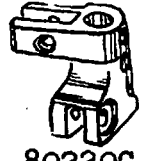

80220C



80220B



80220D

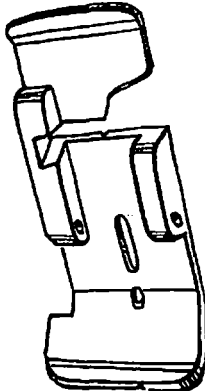

80627L

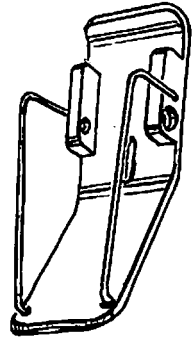

80620R



81220D

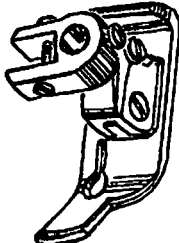

80220

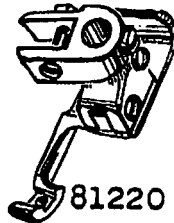

81220

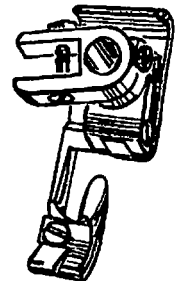

81220A

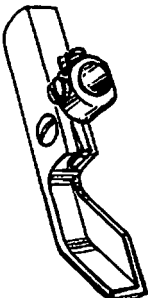

80220A

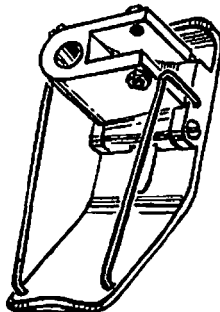

80620Q

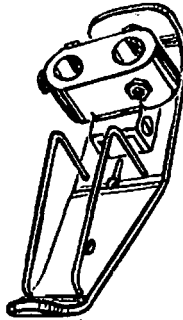

80627E

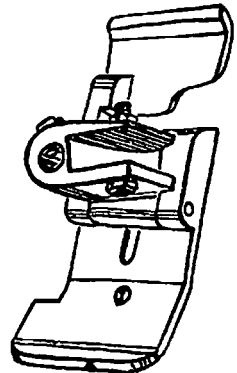

80627M

Plate No. 12 - One-Half Size

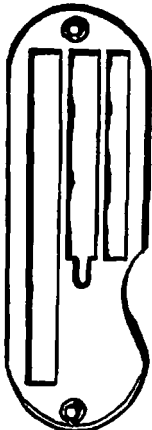

80224

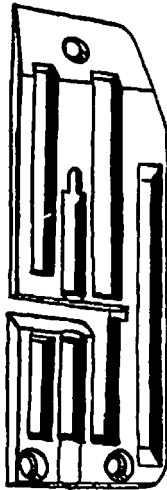

80628H



80624D



80628E



80624 E

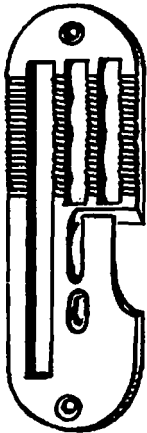

K57187

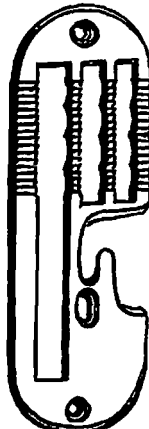

81224I

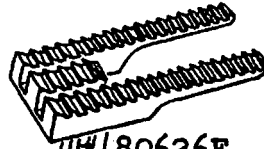

80626E

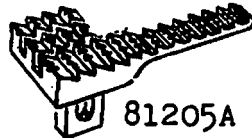

81205A

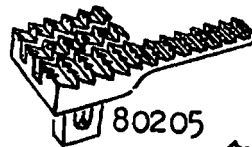

80205

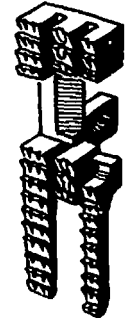

80605H

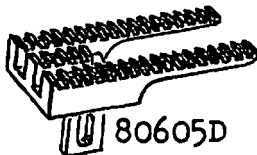

80605D

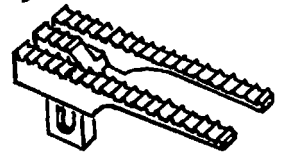

80605 E

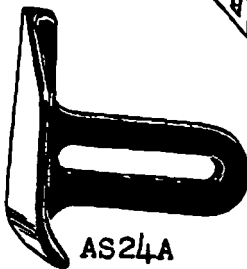

AS24A

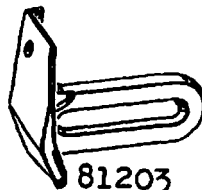

81203

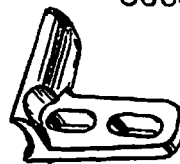

897B



80620E

Plate No. 13 - One-Half Size



80680



80680A



HA54A



80638A



81213

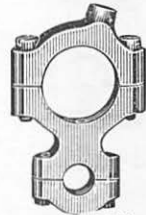

15865



80621A

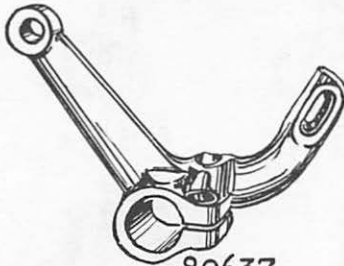

80637



29132S

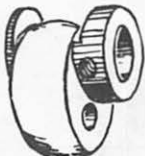

80642

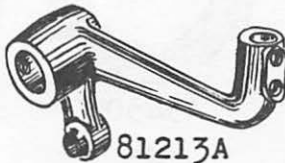

81213A

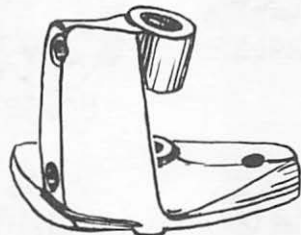

81255



21703



80672



1230A



15442K



15442L

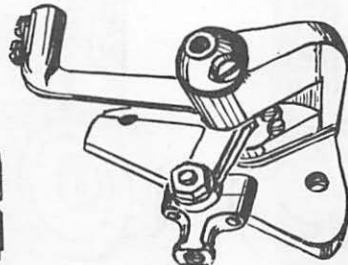

29198

Plate No. 14 - One-Half Size



29442L

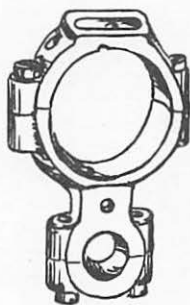

80236



80636

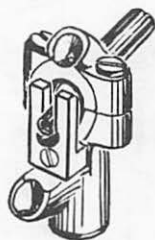

29066L



29442N



29194A



80613A

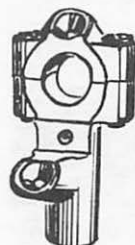

80650

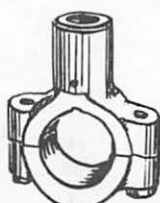

80652

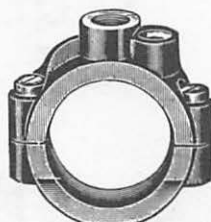

15430M



29132 U

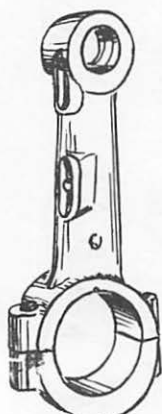

80651

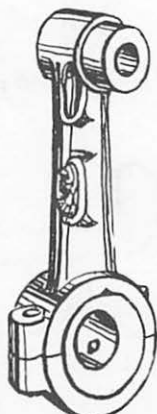

G29099M



29099S



29099V

Plate No. 15 - One-Half Size

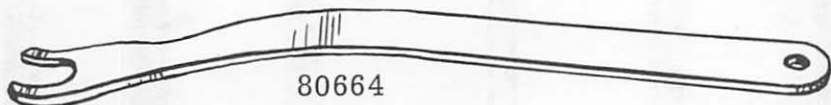
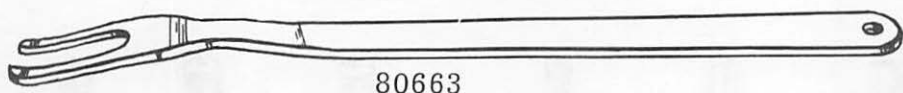

80437 A

80673 C

39144

81251 A

8564

23451 G



41331 G

51134 V

424

23451 H

80643



81260

80278

80279

15430 L

81261

80239

80639

Plate No. 16 - One-Half Size



80408 A



8 A



80630



80411



11



459



80640



21113 A



81240



80617



80660



80661



80661 A

Plate No. 17 - One-Half Size



80653H

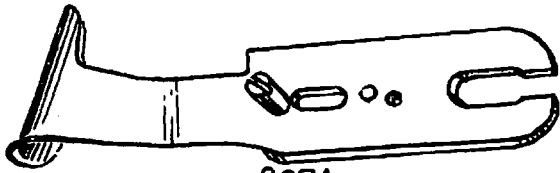

897A



80653

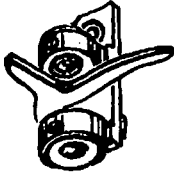

80653I

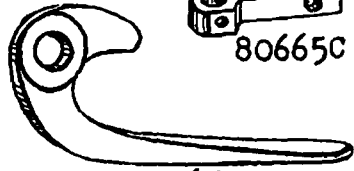

80267



80665C

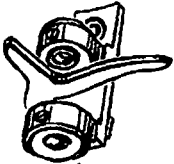

80653A



80623



80604



81250E



80665D



80665



81250G



80250A



80250

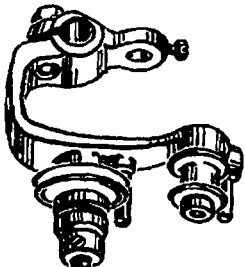

29774D

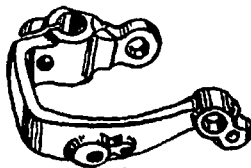

80659



80665A



80665B

Plate No. 18 - One-Half Size



21104 C



21104 E

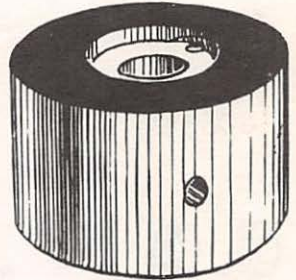

80685

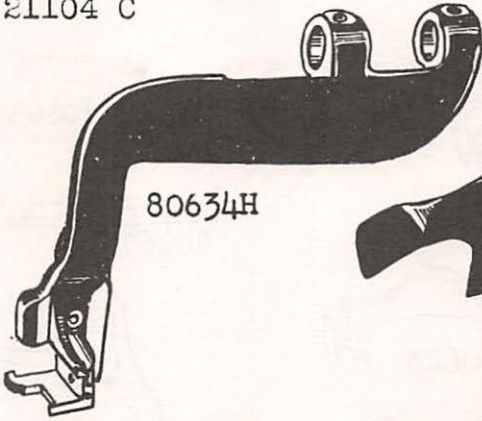

80634H

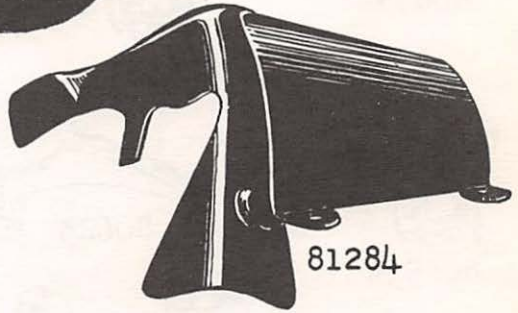

81284

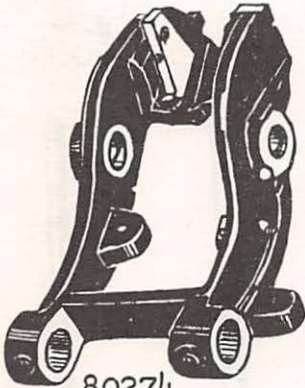

80274

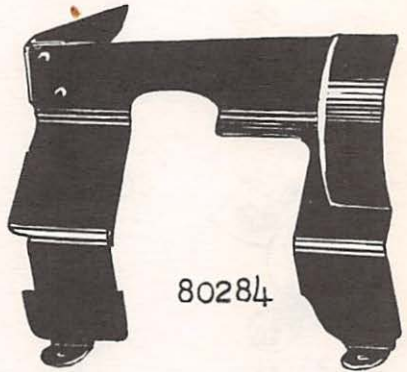

80284

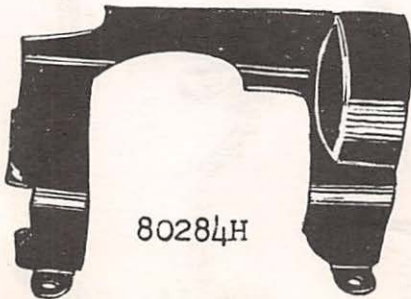

80284H

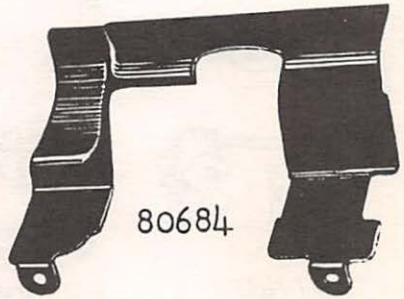

80684

Plate No. 19 - One-Half Size

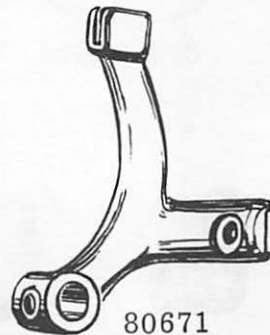
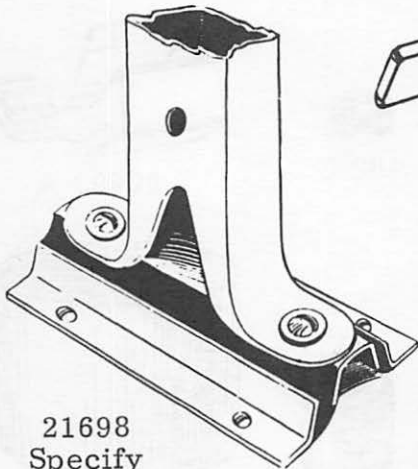
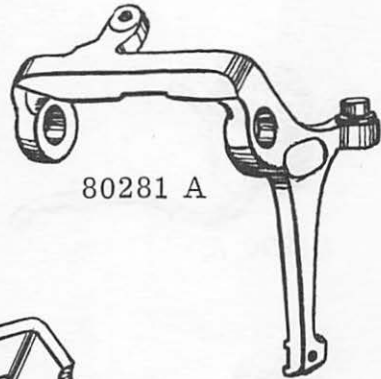
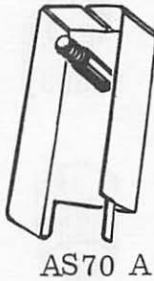
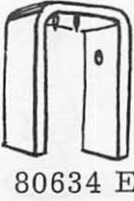
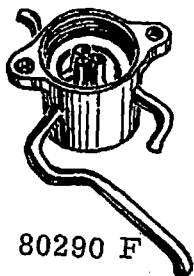

Plate No. 20 - One-Half Size



80290 F



80293



80293 A



80290 G

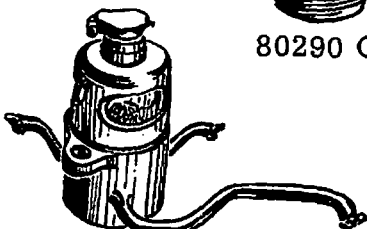

81290



80693



666-79

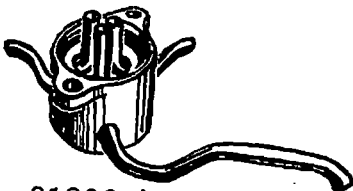

81290 A



666-8 D



80199 K

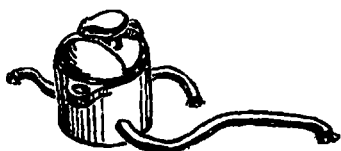

80290 E



482 C



80698 A

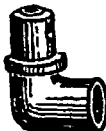

80698

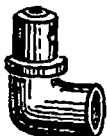

80698 B



80290 B

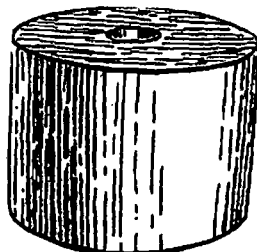

21171 Q

Plate No. 21 - One-Half Size



21207



21388 R



21388 C



21388 AH



21681 B



21388



116



116 A



423

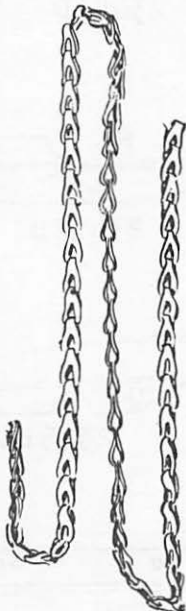

421 D-38

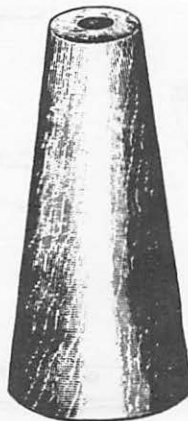

21145

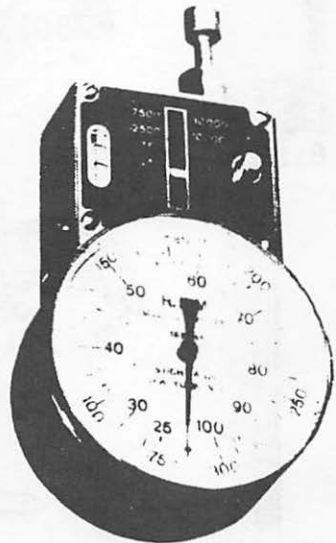

TA55

Plate No. 22 - One-Fourth Size

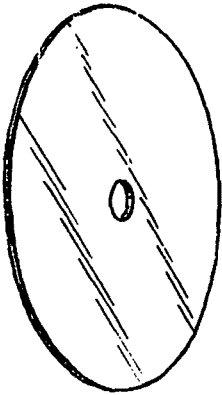

21171L

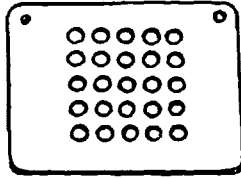

80683

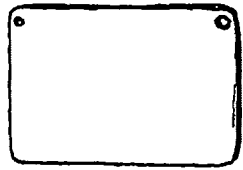

80683H



80615

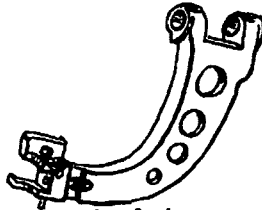

80634C



23451E

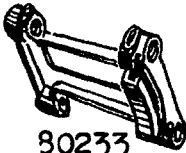

80233

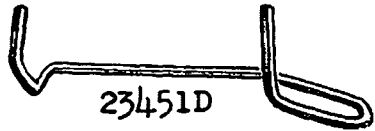

23451D

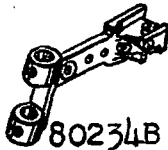

80234B



81237



23451B

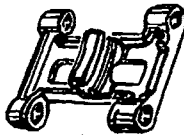

80633H



23451A



23451M



23451C

Plate No. 23 - One-Fourth Size



80222



80622



80622H



81222

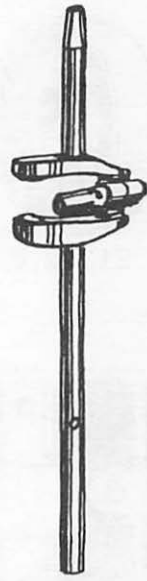

29781



G29781H



29782



29782H



21104U



21104B
Specify
Length

Plate No. 24 - One-Fourth Size

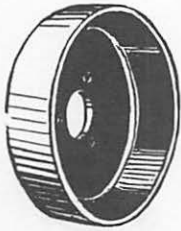

21382 F

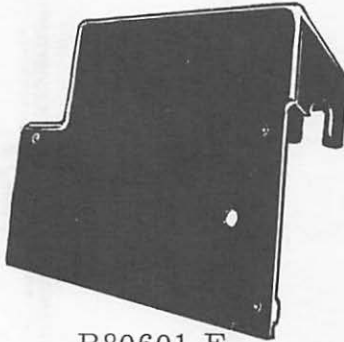

B80601 E

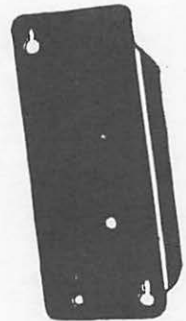

B80687

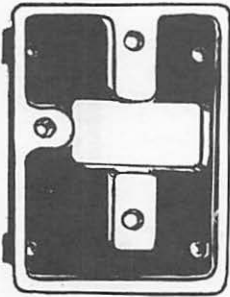

11667 P

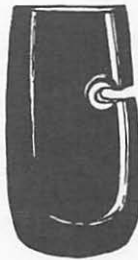

B80688

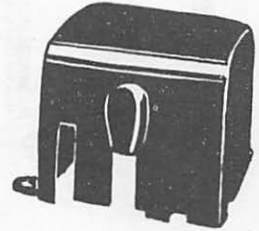

B80697

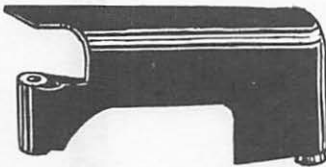

B80601 P



80648



B80621 B

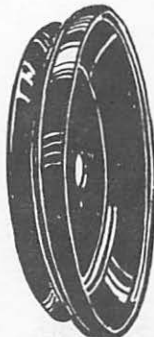

B80621 H



21382 D

Plate No. 25 - One-Fourth Size

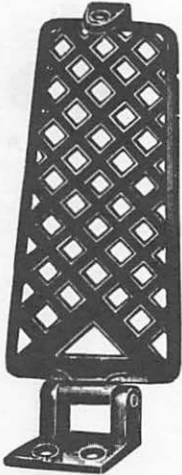

29402

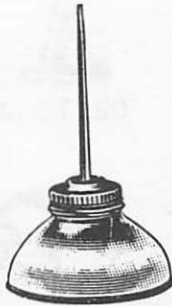

413



21236



21201

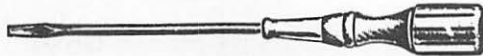

21202

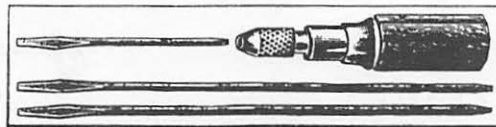

21208



21205A



21203



21204

Plate No. 26 - One-Eighth Size



G21139A



21130S



G21104A



21114 A



21104D

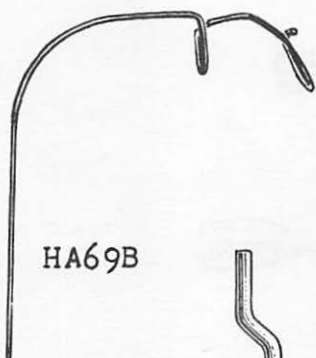

HA69B



HA118



G69T



OI-19



21104T



21104G

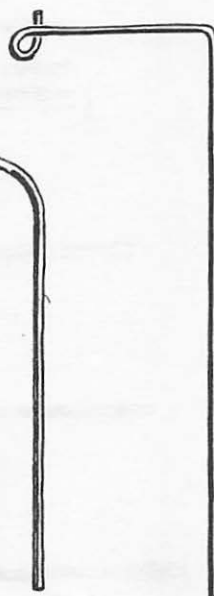

211130



G69R



21104K

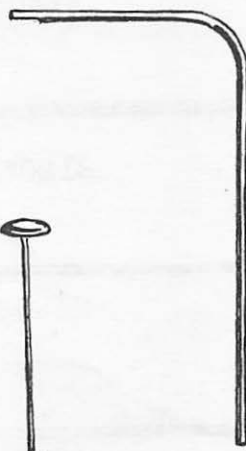

21385D

21171M

Plate No. 27 - One-Eight Size

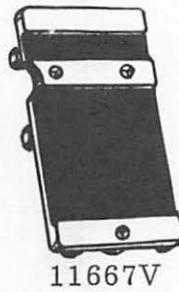
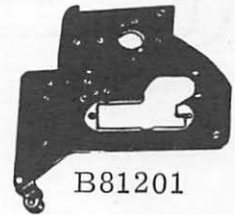
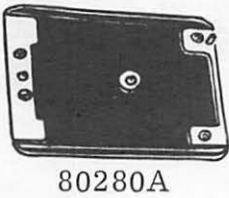
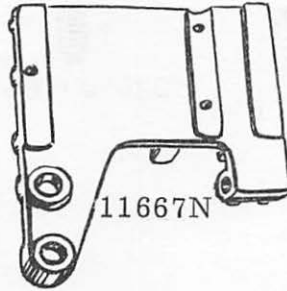

Plate No. 28 - Full Size



22894 L



22650 CE-6



22650 CB-4



22650 CB-3

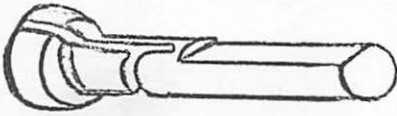

80665 E

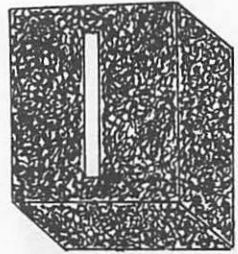

80634 EB



80665 F



22894 D



22840 A



22706 A



22894 K



22729 C



51292 F-4



25 CC



22894 C



51430 F



22548

LIST OF PARTS

Symbol to Order By	The figures in the last column refer only to the plates illustrating the parts and are not to be used in ordering. Prices furnished on application.	Plate No.
8 A	Feed Rocker Shaft, 5 25/32 inches long, standard diameter .407 inch, for styles in Classes 80200, 81200-----	16
HA10	Feed Bar Prong, for styles in Classes 80200, 81200 (screw No. 93 A)-----	19
11	Feed Bar Shaft, 3 1/2 inches long, standard diameter .407 inch, for styles in Classes 80200, 81200-----	16
WA15 A	Stop Watch-----	10
HS15 A	Feed Driving Eccentric, stitch range 2 to 4 per inch, for styles in Classes 80200, 81200 (screw No. 81)---	9
18	Nut, for looper drive connecting rod, right thread; also for Nos. AS70 A, 897 F, 6038 K, 6039 K, 10349, 41331 G, 80658 A-----	6
HA18 A	Nut, for stitch regulating stud-----	6
OI-19	Pressure Pump Oil Can, 1 1/2 pints capacity-----	26
20	Washer, for feed cam sponge holder, on styles in Classes 80200, 81200-----	6
HA20 A	Stitch Regulating Stud Washer-----	6
22 KH	Screw, for loop retainer on styles in Class 81200---	3
AS22 D	Screw, for looper thread cast-off on styles in Classes 80200, 80600-----	4
HA23	Feed Bar Shoe, for styles in Classes 80200, 81200 (screw No. 93 A)-----	19
AS24 A	Cloth Plate Edge Guide, for Styles 80200 AA, 80200 AB (screw No. 22514)-----	12
HS24 C	Screw, for edge guide tongue on Style 81200 A-----	3
25 CC	Screw, on Style 80600 H-----	28
T26	Stop Screw, for stitch regulating stud-----	3
AS26 XA	Looper, for Styles 80200 AA, 80200 AC, 80600 E, 80600 H, 80600 J, 80600 M, 80600 N, 80600 P, 80600 AC (screw No. 73)-----	1
28 C	Set Screw, for frame thread eyelet; also for No. 81253-	3
HS36 K	Looper Connecting Rod Ball Joint Washer-----	6
AS38 B	Looper Avoid Eccentric, for styles in Classes 80200, 80600 (screw No. 81)-----	9
C41	Hinge Screw, for presser foot on Styles 80600 E, 80600 F, 80600 N, 80600 P-----	4
42 A	Screw Pin, for hemming guide on Style 80200 AC----	5
HA43 X	Feed Lift Cam, for styles in Classes 80200, 81200; also Style 80600 H (screw No. 96)-----	9
HS52 B	Frame Rolling Thread Guide Axle Assembly, for styles in Classes 80200, 81200; also styles 80600 E, 80600 H, 80600 J, 80600 M, 80600 N, 80600 P, 80600 AC, 80600 AD; one each Nos. HA1286 B, 12964 C, 22560, 81086 C (screw No. 88)-----	8
HS53 B	Needle Thread Take-up Rolling thread Guide; one each Nos. HS1286 B, 12964 C, 22560, 81086 G (screw No. 88)-----	8
HA54 A	Needle Bar Link-----	13
TA55	Hand Tachometer, 3000 to 12,000 R. P. M.-----	21
HA56	Needle Clamp Nut-----	6

LIST OF PARTS

Symbol to Order By	The figures in the last column refer only to the plates illustrating the parts and are not to be used in ordering. Prices furnished on application.	Plate No.
57 WD	Screw, for tape cutter upper knife operating ratchet block spring on Style 80600 H -----	4
HA58 C	Needle Bar Connection Tension Ferrule, 13/32 inch hole -----	2
HA58 D	Needle Bar Connection Tension Ferrule, 7/32 inch hole -----	2
HA58 F	Needle Bar Connection Tension Spring -----	10
HA61 D	Screw, for looper thread cast-off support on styles in Classes 80200, 80600 -----	3
64 Y	Presser Spring Regulator Screw -----	10
HA65 E	Hinge Screw, for right presser foot on styles in Classes 80200, 81200 -----	3
HA65 L	Hinge Screw, for left presser foot on styles in Classes 80200, 81200 -----	4
HA66 K	Key, for pulley hub -----	6
69 H	Washer, for feed dog screw on styles in Class 80600; also for Nos. 15442 K, 80698 A -----	6
69 V	Thread Rod Extension Pin, for styles in Classes 80200, 81200 -----	8
69 FD	Set Screw, square head, cup point, 5/16 inch diameter, 18 threads per inch, 5/8 inch long, for thread stand rod, also for No. 21171 N -----	4
G69 R	Thread Wire Extension, .375 inch diameter, for styles in Classes 80200, 81200 -----	26
G69 T	Thread Stand Rod, .375 inch diameter, for styles in Classes 80200, 81200 (set screw No. 69 FD)-----	26
HA69 B	Thread Rod, for styles in Classes 80200, 81200-----	26
AS70 A	Feed Cam Oiling Felt Holder, for styles in Classes 80200, 81200 (nut No. 18, washer No. 20)-----	19
HS70 A	Feed Cam Oiling Felt, for styles in Classes 80200, 81200-----	19
73	Set Screw, for loopers in styles in Classes 80200, 80600; also for No. 897 A -----	3
73 C	Screw, for supporting feed dog and throat plate on Style 80600 H-----	3
73 X	Set Screw, for loopers on styles in Class 81200-----	3
74	Screw, for hemming guide operating lever on Style 82000 AC -----	4
74 A	Screw, for tape folder sections on Style 80600 H ----	4
74 E	Screw, for main shaft collar-----	3
75 A	Screw, upper, for chain cutting knife driving eccen- tric bearing on Styles 80600 E, 80600 F, 80600 J, 80600 M, 80600 N, 80600 P, 80600 AC, 80600 AD --	4
77	Set Screw, fillister head, for tape cutter upper knife operating ratchet block link pin on Style 80600 H ---	3
J79 J	Screw, for looper thread take-up on styles in Classes 80200, 80600 -----	3
80	Screw, for throat plate on styles in Class 80600; also for Nos. B80621 B, B80621 H, 80674 -----	4
81	Screw, for feed driving eccentric; also for Nos. HS15 A, AS38 B, 80615, 80693 -----	3

LIST OF PARTS

Symbol to Order By	The figures in the last column refer only to the plates illustrating the parts and are not to be used in ordering. Prices furnished on application.	Plate No.
HA81	Spot Screw, for mainshaft bushing housing-----	3
82	Hemming Guide Stop Screw, for Style 80200 AC ---	5
85	Adjusting Screw, for looper eccentric fork on styles in Classes 80200, 80600-----	4
88	Set Screw, for needle lever shaft hole plug screw; also for Nos. HS52 B, HS53 B, 460, 15465 F, 21111, 21113 B, 80278, 80627 E, 80665 C -----	3
88 A	Set Screw, fillister head, for presser feet on styles in Class 80200; also Styles 81200 A, 81200 H, 80600 H, 80600 AC, 80600 AD-----	3
88 B	Set Screw, headless, for presser feet-----	3
88 D	Screw, for stationary knife on Styles 80600 E, 80600 F, 80600 J, 80600 M, 80600 N, 80600 P, 80600 AC, 80600 AD-----	3
88 F	Screw, for looper drive eccentric connecting bearing -	4
89	Set Screw, for feed rocker; also for Nos. B80201 A, B80201 E, 80233, 80234 B, 80246, B80601 I, B80601 P, 80633 H, 80634 C, 80634 H, 80646, 80647, B81201 A-	3
90	Screw, for throat plate needle guard on styles in Class 81200; also for Nos. 23451 J, 29198, 81211-----	3
91	Screw, upper, for needle lever link pin -----	3
93	Screw, for feed dogs on Styles 80600 E, 80600 AC, 80600 AD, and on styles in Classes 80200, 81200; also for Nos. 80277, 80286 A -----	3
93 A	Screw, for feed bar needle guard on styles in Classes 80200, 81200; also for Nos. HA10, HA23, 80269, 80634 E, B80697-----	3
94	Screw, for presser bar lifter guide plate; also for Nos. 80271, 80284, 80284 H, 80288 F, 80631, 80680 B, 80684, 81284-----	3
95	Set Screw, for needle bar rolling thread guide; also for Nos. AS137 A, 80250, 80293, 80293 A, 80615, 80632, 80665 A, 80665 D, 81213 -----	3
HA95	Set Screw, for mainshaft bushing housing; also for No. 80625-----	3
96	Spot Screw, for Nos. 80638 A, 80672-----	3
96 A	Spot Screw, for needle lever connecting rod bearing oil reservoir No. 80293 A or 80693; also for Nos. 23451 D, 23451 E, 23451 F -----	3
97	Screw, for tape cutter actuating shoe on Style 80600 H-	3
97 A	Screw, for Nos. 15442 L, 15865-----	4
97 X	Screw, for supporting feed dog on styles in Classes 80200, 81200; also for Styles 80600 E, 80600 F, 80600 J, 80600 M, 80600 N, 80600 P, 80600 AC, 80600 AD -----	3
98	Screw, for Nos. 80671, 81213 A -----	3
HS100 D	Stop Screw, for tension discs -----	5
HA102 A	Looper Thread Cast-off Support Eyelet, for styles in Classes 80200, 80600 (screw No. 22743) -----	2
HA103 B	Frame Thread Eyelet (screw No. 28 C) -----	2
HS106	Tension Post, length overall 2 9/16 inches -----	10

LIST OF PARTS

Symbol to Order By	The figures in the last column refer only to the plates illustrating the parts and are not to be used in ordering. Prices furnished on application.	Plate No.
107	Tension Spring Ferrule -----	2
108	Tension Regulating Nut-----	6
BP108	Clamp Screw, for needle bar connection; also for No. 80656 -----	4
110-2	Tension Spring, .029 inch diameter wire, for looper threads-----	10
110-3	Tension Spring, .041 inch diameter wire, for looper threads-----	10
110-4	Tension Spring, .049 inch diameter wire, for needle thread-----	10
HS110	Tension Spring, .049 inch diameter wire, for tape cutter upper knife actuating lever -----	10
116	Wrench, 1/8 inch thick, 9/32 inch opening -----	21
116 A	Wrench, 3/32 inch thick, 7/32 inch opening -----	21
HA118	Thread Hook, for styles in Class 81200 -----	26
136	Clamp Screw, for looper drive lever shaft rocker--	3
AS137	Frame Thread Eyelet Support-----	2
AS137 A	Frame Thread Eyelet Assembly; one each Nos. 28 C, HA103 B, AS137 (screw .214 inch diameter, No. 95, screw .182 inch diameter, No. 22560 B)-----	2
188 D	Thumb Screw, for tape holder axle on Style 81200 H-	5
258	Nut, for lifter lever screw pin; also for Nos. 22720, 23451 A, 23451 B-----	6
269	Nut, for looper drive connecting rod, left thread---	6
318	Clamp Screw, for looper avoid eccentric fork, also for No. 81255 -----	4
376	Screw, for face plate -----	3
376 A	Screw, for front fabric edge guide on Style 81200 A-	3
413	Oil Can, complete-----	25
420	Lifter Lever Stud-----	5
421 D-38	Lifter Lever Chain, 38 inches long-----	21
423	Lifter Treadle Base -----	21
424	Lifter Treadle Pin (screw No. 22813)-----	15
459	Chain Cutter Knife Lever Shaft, for Styles 80600 E, 80600 F, 80600 J, 80600 M, 80600 N, 80600 P, 80600 AC, 80600 AD-----	16
460	Chain Cutter Knife Lever Shaft Collar, for Styles 80600 E, 80600 F, 80600 J, 80600 M, 80600 N, 80600 AC,, 80600 AD (screw No. 88)-----	19
482 C	Presser Bar Collar, also Feed Bar Shaft Collar (screw No. 22894 C)-----	20
531	Stop Screw, for presser foot shank on Style 80600 H (nut No. 12934 A)-----	3
650-24	Stove Bolt, flat head, 1/4 x 3 inches, for attaching baseplate to table on styles in Classes 80200, 81200-	5
651 B-40	Nut, for folder support stud on Style 80600 H-----	6
652-24	Washer, 1/4 inch, for base plate stove bolt on styles in Classes 80200, 81200; also for No. 11667 K---	6
652-40	Washer, 5/8 inch, for folder support stud on Style 80600 H -----	6

LIST OF PARTS

Symbol to Order By	The figures in the last column refer only to the plates illustrating the parts and are not to be used in ordering. Prices furnished on application.	Plate No.
660-240	Thread Tweezers-----	--
664 F-16	Taper Dowel Pin, for upper section of bed, on machines of American manufacture only -----	8
666-8 A	Gasket, leather, for cloth plate oil reservoir on styles in Classes 80200, 81200 -----	6
666-8 D	Glass Tube, for cloth plate oil reservoir on styles in Class 81200 -----	20
666-8 E	Gasket, with 7/16 inch hole, for cloth plate oil reservoir on styles in Class 81200 -----	6
666-79	Oil Cup Assembly, with sight feed and signal stop (for machines of American manufacture only) ----	20
666-90	Oil Cup, for cloth plate oil reservoir assembly on styles in Class 80200 -----	2
897 A	Hemming Guide, adjustable, for Style 80200 AC (stud No. 22720, adjusting screw No. 82, operating lever screw pin No. 42 A, operating lever stop screw No. 73)-----	17
897 B	Fabric Edge Guide, for Style 80200 AC (screw No. 22548)-----	12
897 E	Tension Spring, for hemming guide on Style 80200 AC-----	10
897 F	Hemming Guide Operating Lever, for Style 80200 AC (screw No. 74)-----	8
906	Stop Screw, hexagonal head, for tape cutter upper knife operating ratched block on Style 80600 H (lock nut No. 907, washer No. 80266) -----	4
906 A	Stop Screw, hexagonal head, for tape cutter upper knife actuating lever on Style 80600 H; also for No. 80271 (lock nut No. 907) -----	4
907	Locknut, for tape cutter upper knife operating ratchet block stop screw on Style 80600 H; also for Nos. 906, 906 A, 22525 C, 22707, 99246-----	6
‡ 1230 A	Connection Bearing, upper, for tape cutter driving eccentric connecting rod assembly, on Style 80600 H (screw No. 22587) -----	13
1230 B	Valve Spring, for tape cutter driving eccentric connecting rod upper bearing, on Style 80600 H-----	10
1230 D	Valve, for tape cutter driving eccentric connecting rod upper bearing on Style 80600 H (screw No. 22586 A)-----	8
1280	Looper Rocker Cone Stud Nut, for styles in Classes 80200, 80600-----	6
1286 B	Needle Lever Link Pin Spring-----	10
HA1286 B	Frame Rolling Thread Guide Axle Spring; also for No. HS53 B (screw No. 22560)-----	10
HA1348	Frame Tension Post Ferrule, front -----	2
1349 A-3	Tension Spring, for tape holder on Style 81200 H---	10
1349 A-5	Tension Spring, for looper thread on styles in Class 81200 -----	10
HA1349	Frame Tension Post Ferrule, rear-----	2
‡ See Page 8		

LIST OF PARTS

Symbol to Order By	The figures in the last column refer only to the plates illustrating the parts and are not to be used in ordering. Prices furnished on application.	Plate No.
6038 K	Looper Rocker Connecting Rod Ball Joint, left, for styles in Class 81200 (screw No. 22729 C, ball stud nut No. 18)-----	9
6039 K	Looper Rocker Connecting Rod Ball Joint, right, for styles in Classes 80200, 81200 (nut No. 18)-----	9
6042 A	Washer, for tape folder sections on Style 80600 H---	6
8372 A	Washer, for No. 80275 on Style 80600 H-----	6
8564	Cloth Plate Swinging Extension Hinge Pin, for styles in Class 80600-----	15
9937	Looper Rocker Double Ball Joint Stud Nut, for styles in Class 81200-----	6
10349	Chain Cutting Knife Eccentric Bearing Ball Stud, for Styles 80600 E, 80600 F, 80600 J, 80600 M, 80600 N, 80600 P, 80600 AC, 80600 AD (nut No. 18)-----	9
11354	Looper Rocker Double Ball Joint Stud, for styles in Class 81200-----	9
11639 H	Hand Lifter Stud, for styles in Classes 80200, 81200-	5
11667 K	Sewing Head Adaptor Plate, for Styles 80600 E, 80600 F, 80600 J, 80600 M, 80600 N, 80600 P, 80600 AC, 80600 AD (screw No. 22638 B)-----	27
11667 N	Sewing Head Adaptor Base, for Style 80600 H (screw No. 22639 B)-----	27
11667 P	Sewing Head Adaptor Base, for Styles 80600 E, 80600 F, 80600 J, 80600 M, 80600 N, 80600 P, 80600 AC, 80600 AD, when used on filled bag closing frame Style 20100 E (screw No. 22639 B)-----	24
11667 V	Sewing Head Adaptor Base, for Styles 80600 E, 80600 F, 80600 J, 80600 M, 80600 N, 80600 P, 80600 AC, 80600 AD, when used on filled bag closing frames in Classes 20500, 21800; also for Style 20100 H (screw No. 22639 B)-----	27
12538	Looper Rocker Ball Joint Nut, for styles in Classes 80200, 80600-----	6
12934 A	Locknut, for presser foot shank adjusting screws on styles in Class 80600-----	6
12957 E	Spring Washer, for end cover on styles in Class 80600-	6
12964 C	Link Pin Ball, for Nos. HS52 B, HS53 B-----	6
12987 A	Check Nut, for looper rocker cone stud-----	6
15430 C	Nut, left thread, for tape cutter knife connecting rod tube on Style 80600 H-----	6
15430 D	Nut, right thread, for tape cutter knife connecting rod tube on Style 80600 H-----	6
15430 L	Needle Lever Connecting Rod Tube Felt; also for No. 80230 on Style 80600 H-----	15
‡15430 M	Tape Cutter Driving Eccentric Bearing (screw No. 22587)-----	14
15442 K	Looper Rocker Double Ball Joint Connection Assembly, for styles in Class 81200; one No. 15442 L and two No. 11354 (screw No. 97 A, washer No. 69 H, nut No. 9937)-----	13

‡ See Page 8

LIST OF PARTS

Symbol to Order By	The figures in the last column refer only to the plates illustrating the parts and are not to be used in ordering. Prices furnished on application.	Plate No.
‡15442 L	Looper Rocker Double Ball Joint Connection (screw No. 97 A)-----	13
15444 F	Looper Rocker Ball Joint Stud Washer, for styles in Class 81200-----	6
15465 F	Looper Rocker Cone (screw No. 88)-----	6
15745 B	Looper Rocker Cone Stud, for styles in Classes 80200, 80600-----	9
‡15865	Chain Cutter Knife Driving Eccentric Bearing, for Styles 80600 E, 80600 F, 80600 J, 80600 M, 80600 N, 80600 P, 80600 AC, 80600 AD (screw, upper, No. 75 A, screw, lower, No. 97 A)-----	13
21104 B-2	Thread Stand Rod, 2 inches long, for styles in Class 80600 (Screw No. 22509)-----	23
21104 B-5	Thread Stand Rod, 5 inches long, for styles in Class 80600 (screw No. 22509)-----	23
21104 B-9	Thread Stand Rod, 9 inches long, for styles in Class 80600 (screw No. 22509)-----	23
21104 B-14	Filter Cord Support Rod; also thread stand rod for Styles 80600 E, 80600 F, when used on filled bag closing frames in Class 21800 (screw No. 22509)---	23
21104 B-18	Filter Cord Support Rod, for Style 80600 H; also tape holder rod for Style 81200 H (filter cord support rod screw No. 22509 A) tape holder rod screw No. 22651 CD-4)-----	23
21104 B-20	Filter Cord Support Rod; also thread stand rod, for Styles 80600 E, 80600 F, when used on filled bag closing frames in Classes 20100, 20500 (screw No. 22509)-----	23
21104 C	Thread Stand Rod Connection; also filter cord support rod connection on styles in Class 80600 (screw No. 22650 CE-6)-----	18
21104 D	Thread Stand Seat, for styles in Class 80600 (screw No. 22650 CB-3)-----	26
21104 E	Thread Stand Seat Connection; also filter cord spool seat connection, for styles in Class 80600-----	18
21104 F	Spool Seat Pad-----	27
21104 G	Thread Stand Seat Pin, also Filter Cord Seat Pin, for styles in Class 80600-----	26
21104 H	Thread Stand Seat Pin Nut; also Filter Cord Seat Pin Nut, for styles in Class 80600-----	6
21104 K	Thread Stand Wire, 16 inches long, for styles in Class 80600 (screw No. 22650 CB-3)-----	26
21104 T	Thread Stand Rod, 7 inches long, with shoulder, for styles in Class 80600-----	26
21104 U	Filter Cord Support Rod, 24 inches long, with shoul- der, for Styles 80600 E, 80600 F, when used on filled bag closing machine frames in Class 21800 (nut No. 21818 B)-----	23
‡ See Page 8		

LIST OF PARTS

Symbol to Order By	The figures in the last column refer only to the plates illustrating the parts and are not to be used in ordering. Prices furnished on application.	Plate No.
G21104 A	Thread Stand Base, with .375 inch diameter hole, for styles in Classes 80200, 81200 (screw No. 22650 CE-6)-----	26
21105 J	Thread Stand Wire Eyelet, for styles in Class 80600--	10
21111	Needle Bar Connection Tension Post Collar (screw No. 88)-----	2
21113 A	Thread Wire Extension, 6 inches long, for styles in Class 80600 (screw No. 22632 F-24)-----	16
21113 B	Thread Stand Wire Coupling, for styles in Class 80600 (screw No. 88)-----	8
21113 C	Filter Cord Guide Wire, for styles in Class 80600 (screw No. 22509 A)-----	26
21114 A	Tape Holder Support Rod Base, for Style 81200 H (screw No. 22651 CD-4)-----	26
21130 S	Filter Cord Cone Support, for styles in Class 80600 (screw No. 22650 CD-4)-----	26
G21139 A	Thread Stand Seat, single, for styles in Classes 80200, 80600, 81200 (screw Nos. 22650 CB-4, 22650 CE-6)-----	26
21145	Cone, wood, for thread stand-----	21
21171 L	Tape Holder Disc, 8 inches diameter, for Style 80600 H-----	22
21171 M	Tape Reel Support Rod, for Style 80600 H (screw No. 22809 A)-----	26
21171 N	Tape Holder Disc Stop Collar, for Style 80600 H (screw, square head, No. 69 FD, thumb screw No. 22647 K-48)-----	2
21171 P	Tape Holder Disc Tension Spring, for Style 80600 H--	10
21171 Q	Tape Roll Plug, wood, for Style 80600 H-----	20
21201	Screwdriver, 9/64 inch round blade, length overall 7 11/16 inches-----	25
21202	Screwdriver, 3/16 inch round blade, length overall 10 3/4 inches-----	25
21203	Screwdriver, 3/16 inch round blade, length overall 11 3/8 inches-----	25
21204	Screwdriver, 7/32 inch round blade, length overall 15 inches-----	25
21205 A	Screwdriver, 3/8 inch round blade, length overall 14 5/8 inches-----	25
21207	Screwdriver, 7/64 inch round blade, length overall 2 1/2 inches-----	21
21208	Screwdriver Set, three detachable blades-----	25
21217 A	Tape Holder Spool Pin Support, for Style 81200 H (screw Nos. 22650 CB-4, 22651 CD-4)-----	10
21225-1/4	Looper Adjusting Gauge, 1/4 inch measurement----	10
21225-5/16	Looper Adjusting Gauge, 5/16 inch measurement----	10
21236	Belt Plier, for 3/8 inch and smaller round belt----	25
21260	Emery Cord, 3/64 inch diameter, grade No. 120, fifty yard spool-----	--
21260 A	Emery Cord, 3/64 inch diameter, grade No. 150, fifty yard spool-----	--

LIST OF PARTS

Symbol to Order By	The figures in the last column refer only to the plates illustrating the parts and are not to be used in ordering. Prices furnished on application.	Plate No.
21260 B	Emery Cord, 1/32 inch diameter, grade No. 180, fifty yard spool-----	--
21260 C	Emery Cord, .030 inch diameter, grade No. 200, fifty yard spool-----	--
21260 D	Emery Tape, 3/32 inch wide, .025 inch thick, grade No. 180, fifty yard spool-----	--
21260 E	Emery Cord, .018 inch diameter, grade No. 200, fifty yard spool-----	--
21261	Leather Belt, flat, 1 inch wide, 63 inches long, includes belt fastener No. 21350, for styles in Classes 80200, 81200-----	--
21262	Leather Belt, round, 9/32 inch diameter, 44 inches long, includes wire belt hook No. 21351, for styles in Classes 80200, 81200-----	--
21262 A	Leather Belt, round, 9/32 inch diameter, 60 inches long, includes wire belt hook No. 21351, for styles in Class 80600 when used on filled bag closing machine frames in Class 21800-----	--
21262 C-37	Leather Belt, "V" type, 5/16 inch outer width, includes wire belt hook No. 21351, for styles in Class 80600 when used on filled bag closing machine frame Style 20100 E-----	--
21262 D-156	Leather Belt, round, 3/8 inch diameter, 156 inches long, includes wire belt hook No. 21351 A, for styles in Class 80600 when used on filled bag closing machine frames in Class 20500, also filled bag closing machine frame Style 20100 H-----	--
21350	Belt Fastener, malleable iron, for 1 inch flat belt--	2
21351	Belt Hook, wire, for 9/32 inch round belt-----	10
21351 A	Belt Hook, wire, for 3/8 inch round belt-----	10
21371 Q	Table Drawer-----	--
21371 BT-42	Table Top, blank, 42 x 16 x 1 3/4 inches-----	--
21382 D	Pulley Rim, with 6 inches working diameter belt groove, for Styles 80600 E, 80600 F (screw No. 22597 A)-----	24
21382 F	Machine Pulley Rim, 4 1/2 inches diameter, for Styles 80600 N, 80600 P-----	24
21385 D	Tape Holder Axle, for Style 81200 H (screw No. 188 D)-----	26
21388	Wrench, single end, 3/8 inch opening-----	21
21388 C	Wrench, single end, 1/16 inch thick, 9/32 inch opening-----	21
21388 R	Wrench, double end, 3/8 and 1/2 inch openings---	21
21388 AH	Wrench, 1/8 inch thick, 1/4 inch opening-----	21
21394	Utility Grinder, including emery wheel, 5 inch diameter, 1/4 inch face, round belt drive, recom- mended speed 3000 R.P.M.-----	--
21394 G	Emery Wheel, 5 inches diameter, 1/4 inch face, 3/8 inch hole, grade "M" emery 60-----	--

LIST OF PARTS

Symbol to Order By	The figures in the last column refer only to the plates illustrating the parts and are not to be used in ordering. Prices furnished on application.	Plate No.
21394 H	Emery Wheel, 5 inches diameter, 1/2 inch face, 3/8 inch hole, grade "M" emery 60-----	--
21394 K	Utility Grinder, including emery wheel, 5 inches diameter, 1/2 inch face, round belt drive, recommended speed 3000 R. P. M.-----	--
21681 B	"T" Screw, for fastening machine to base plate on styles in Classes 80200, 81200-----	21
21698-2	Vibration Insulator, 2 inches long, for table-----	19
21698-4	Vibration Insulator, 4 inches long-----	19
21698-5	Vibration Insulator, 5 inches long-----	19
21698-6	Vibration Insulator, 6 inches long-----	19
	NOTE: Special lengths will be furnished on request. Part of the table leg is shown in the illustration for clarity.	
21703	Tape Cutter Knife Driving Eccentric, for Style 80600 H (spot screw No. 22894 L, set screw No. 22894 C)---	13
G21710	Ball Stud, for tape cutter driving eccentric connecting rod upper bearing on Style 80600 H-----	9
21818 B	Filter Cord Support Rod Nut, for Styles 80600 E, 80600 F when used on filled bag closing machine frames in Class 21800-----	6
21884 C	Tape Folder, Tape Holder, Filter Cord Stand and Sewing Head Adapter Base Assembly, for Style 80600 H; one each Nos. 11667 K, 11667 N, 21104 B-18, 21104 E, 21104 G, 21104 H, 21113 C, 21130 S, 21145, 21171 M, 21171 P, 21171 Q, 22509, 22647 K-48, 23451; two each Nos. 74 A, 652-40, 21171 L, 21171 N, 23451 M; three each Nos. 22509 A, 22639 B; four each Nos. 651 B-40, 22638 B-----	--
22508	Set Screw, square head, cup point, 1/4 inch diameter, 20 threads per inch, 1/2 inch long, for filter cord cone support on styles in Class 80600-----	4
22509 A	Set Screw, square head, 3/8 inch diameter, 16 threads per inch, 5/8 inch long, for filter cord support rod on Style 80600 H; also for No. 21113 C-----	4
22513	Screw, for feed driving eccentric connection oil tube clamp; also for Nos. K49819, 81297-----	3
22514	Screw, for cloth plate edge guide on styles in Classes 80200, 81200-----	3
22515 A	Screw, for looper drive eccentric ball fork-----	4
22517	Screw, for looper drive lever; also for Nos. 80272, 80637, 81238, 81250 E, 81250 G-----	3
22525 C	Clamp Screw, for presser foot shank on styles in Classes 80200, 81200 (locknut No. 907)-----	4
22526	Screw, countersunk head, for throat plates on styles in Classes 80200, 81200-----	4
22528	Screw, for adjustable roller lever support on Style 80600 H-----	5

LIST OF PARTS

Symbol to Order By	The figures in the last column refer only to the plates illustrating the parts and are not to be used in ordering. Prices furnished on application.	Plate No.
22539	Plug Screw, for main shaft bearing sponge hole -----	5
22539 F	Plug Screw, for inner right main shaft bushing oil reservoir -----	5
22548	Screw, for cloth plate edge guide on Style 80200 AC--	28
22557	Screw, for tape cutter upper knife actuating pawl trip lever on Style 80600 H-----	4
22559 J	Screw, for tape cutter upper knife actuating pawl trip dog on Style 80600 H -----	4
22560	Screw, for needle lever link pin spring-----	3
22560 A	Adjusting Screw, for presser foot on Style 80600 H; also for No. 80620 Q-----	3
22560 B	Screw, headless, for frame thread guides; also for Nos. 80627 E, 80627 K-----	3
22562	Screw, for cloth plate oil reservoir on styles in Classes 80200, 81200 -----	3
22564	Screw, for tape cutter upper knife actuating pawl trip lever shoe on Style 80600 H-----	3
22565 C	Set Screw, headless, for needle lever link pin -----	3
22570	Set Screw, fillister head, for presser foot on Styles 80600 E, 80600 F, 80600 N, 80600 P-----	3
22574	Screw, for cloth plate -----	4
22586 A	Screw, for tape cutter driving eccentric connecting rod upper bearing valve on Style 80600 H-----	3
22587	Screw, for needle lever connecting rod upper bear- ing; also for Nos. 1230 A, 80651, 80652, 15430 M-	4
22591	Set Screw, for tape holder support rod base on Style 81200 H-----	3
22596	Screw, for feed dog on Style 80600 F-----	3
22597 A	Screw, for pulley rim on Styles 80600 E, 80600 F---	3
22599	Screw, for tape cutter upper knife actuating pawl trip dog spring on Style 80600 H-----	4
22632 F-24	Screw, square head, cup point, 3/16 inch diameter, 24 threads per inch, 3/8 inch long, for thread stand wires-----	4
22638 B	Screw, flat head, for sewing head adaptor plate on styles in Class 80600 (washer No. 652-24)-----	5
22639 B	Screw, for sewing head adaptor base on styles in Class 80600-----	5
22639 C	Screw, for attaching sewing head to adaptor on Styles 80600 J, 80600 M, 80600 N, 80600 P-----	5
22647 K-48	Thumb Screw, for tape holder disc stop collar on Style 80600 H-----	5
22650 CB-3	Screw, for No. 21104 D-----	28
22650 CB-4	Screw, for No. 21217 A-----	28
22650 CE-6	Screw, for Nos. G21104 A, G21139 A, 21104 C-----	28
22651 CD-4	Screw, for Nos. 21114 A, 21217 A, 21130 S-----	--
22706 A	Screw, for Nos. 80408 A, 80411 on styles in Class 80600-----	28
22707	Screw, for presser foot on Styles 80600 E, 80600 F, 80600 N, 80600 P-----	4

LIST OF PARTS

Symbol to Order By	The figures in the last column refer only to the plates illustrating the parts and are not to be used in ordering. Prices furnished on application.	Plate No.
22720	Hemming Guide Stud, for Style 80200 AC (nut No. 258, adjusting screw No. 82) -----	5
22728	Thumb Screw, for tape reel axle on Style 81200 H---	5
22729	Screw, for needle lever and looper lever ball stud fork-----	3
22729 C	Screw, for looper connecting rod ball joint -----	28
22743	Screw, for looper thread cast-off support eyelet on styles in Classes 80200, 80600; also for No. 80250 B-	3
22760 A	Screw, for tape cutter upper knife actuating pawl trip lever spring on Style 80600 H -----	4
22764	Set Screw, headless, for tape cutter upper knife lever on Style 80600 H-----	3
22768	Screw, for tape cutter upper knife actuating pawl on Style 80600 H-----	3
22806 G	Screw, for tape cutter support on Style 80600 H-----	5
22813	Set Screw, headless, for lifter treadle pin on styles in Classes 80200, 81200 -----	3
22814 B	Screw, front, for attaching upper section of bed to lower section-----	4
22840 A	Screw, for presser foot No. 80620 Q-----	28
22870	Lifter Lever Screw Pin (nut No. 258) -----	5
22874 C	Screw, for feed dog and needle guard, on Style 80600 H-----	4
22894 C	Set Screw, for Nos. 482 C, 21703, 80642-----	28
22894 D	Spot Screw, for feed lift cam-----	28
22894 K	Screw, for No. 80695 A -----	28
22894 L	Spot Screw, for Nos. 21703, 80642 -----	28
23451	Tape Folder and Guide Assembly, for Style 80600 H; one each Nos. 23451 A, 23451 B, 23451 C, 23451 D, 23451 E, 23451 G, 23451 H, 23451 J; two each Nos. 90, 23451 F; three each Nos. 74 A, 258; six No. 6042 A; eight No. 96 A (screw No. 74 A) -----	--
23451 A	Tape Folder, front section, for Style 80600 H (screw No. 74 A, nut No. 258, washer No. 6042 A) -----	22
23451 B	Tape Folder, rear section (screw No. 74 A, nut No. 258, washer No. 6042 A) -----	22
23451 C	Tape Folder, center section -----	22
23451 D	Tape Folder Bag Guiding Wire, front (set screw No. 96 A)-----	22
23451 E	Tape Folder Bag Guiding Wire, rear (set screw No. 96 A)-----	22
23451 F	Tape Folder Tape Guide Collar (screw No. 96 A)----	2
23451 G	Tape Folder Tape Guide, front section-----	15
23451 H	Tape Folder Tape Guide, rear section -----	15
23451 J	Tape Folder Tape Guide Plate (screw No. 90)-----	8
23451 M	Folder Support Stud, for Style 80600 H (nut No. 651 B-40, washer No. 652-40) -----	22
28606-1	Powdered Oil Stone, 1 lb. package -----	--
29066 L	Needle Lever Connecting Rod Upper Bearing Assem- bly; one each Nos. 22729, 80636 A, 80650, 80656---	14

LIST OF PARTS

Symbol to Order By	The figures in the last column refer only to the plates illustrating the parts and are not to be used in ordering. Prices furnished on application.	Plate No.
29099 S	Feed Driving Eccentric Assembly, for Styles 80600 E, 80600 F, 80600 J, 80600 M, 80600 N, 80600 P, 80600 AC, 80600 AD; one each Nos. 80651, 80654, 80695 A-----	14
29099 V	Feed Driving Eccentric Assembly, for styles in Classes 80200, 81200; one each Nos. HS15 A, 80651, 80654-----	14
G29099 M	Feed Driving Eccentric Assembly, for Style 80600 H; one each Nos. 80651, 80654 H, 80695 A-----	14
29111 C	Looper Rocker Cone Stud Assembly, for Class 81200; one each Nos. 15465 F, 81260, 81261; two No. 12987 A-----	--
29132 S	Chain Cutting Knife Driving Eccentric Assembly, for Styles 80600 E, 80600 F, 80600 J, 80600 M, 80600 N, 80600 P, 80600 AC, 80600 AD; one each Nos. 10349, 15865, 39140 H, 80672-----	13
29132 U	Tape Cutter Driving Eccentric Assembly, for Style 80600 H; one each Nos. 15430 M, 21703-----	14
G29139 A	Tape Cutter Driving Eccentric Connecting Rod Upper Bearing Assembly, for Style 80600 H; one each Nos. 1230 A, 1230 B, 1230 D, G21710, 22586 A-----	9
29194 A	Looper Rocker Assembly, for styles in Classes 80200, 80600; one each Nos. 12538, 12987 A, 15465 F, 15745 B, 80613 A, 80657 A; two No. 73---	14
29198	Spreader Rocker Assembly, for styles in Class 81200; one each Nos. 18, 90, 6038 K, 81213 A, 81251 A, 81255; two each Nos. 73 X, 98-----	13
29402	Lifter Treadle Assembly, for styles in Classes 80200, 81200; one each Nos. 422, 423, 424-----	25
29442 L	Looper Drive Eccentric Assembly, for styles in Class 80600; one each Nos. 22515 A, 80636, 80636 A, 80642, 80645-----	14
29442 N	Looper Drive Eccentric Assembly, for styles in Classes 80200, 81200; one each Nos. 22515 A, 80236, 80636 A, 80642, 80645-----	14
29774 D	Needle Bar Connection Assembly; one each Nos. HS52 B, HA58 C, HA58 D, HA58 F, 88, 91, HS100 D, BP108, 21111, 22743, 80046, 80655, 80659, 80669, 81093; two No. 80676-----	17
29781	Main Shaft Assembly, for Styles 80600 E, 80600 F, 80600 J, 80600 M, 80600 N, 80600 P, 80600 AC, 80600 AD; one each Nos. 80622, 80652-----	23
G29781 H	Main Shaft Assembly, for Style 80600 H; one each Nos. 80622 H, 80652-----	23
29782	Main Shaft Assembly, for styles in Class 80200; one each Nos. 80222, 80652-----	23
29782 H	Main Shaft Assembly, for styles in Class 81200; one each Nos. 81222, 80652-----	23
35733 B	Presser Spring Regulator Screw Locknut-----	6

LIST OF PARTS

Symbol to Order By	The figures in the last column refer only to the plates illustrating the parts and are not to be used in ordering. Prices furnished on application.	Plate No.
39140 H	Oiling Felt, for chain cutting knife driving eccentric bearing on Styles 80600 E, 80600 F, 80600 J, 80600 M, 80600 N, 80600 P, 80600 AC, 80600 AD -----	6
39144	Looper Connecting Rod (nut, right thread, No. 18; nut, left thread, No. 269) for Styles in Class 81200 -----	15
41046 G	Spring Valve Oiler, for looper rocker shaft bearing on styles in Class 80200; also for lower presser bar bearing on styles in Class 80600 -----	2
41331 G	Looper Drive Connecting Rod, for styles in Classes 80200, 80600 (nuts Nos. 18, 269) -----	15
K49819	Presser Foot Tongue, for Style 81200 H (screw No. 22513) -----	1
51134 V	Needle Lever Link Pin; also link pin for No. 80287 (screw, upper, No. 91, lower, No. 22565 C; screw No. 77 for No. 80287) -----	15
51292 F-4	Tension Spring, .026 inch diameter wire, for needle thread nipper, on Style 80600 F -----	28
51430 F	Nut, for No. 22840 A on presser foot No. 80620 Q ---	28
K57187	Throat Plate, for Style 81200 H (screw No. 22526) ---	12
K57188	Looper Thread Take-up Eyelet, for Style 81200 H ---	9
76099 G	Tape Cutter Upper Knife Operating Pawl Dowel Pin, for Style 80600 H -----	8
79048	Screw, for needlethread lubricator on Styles 80600 E, 80600 F, 80600 J, 80600 M, 80600 N, 80600 P, 80600 AC, 80600 AD -----	4
80046	Needle Bar Connection Tension Post -----	5
80199 K	Needle Thread Lubricator Felt, for Styles 80600 E, 80600 F, 80600 J, 80600 M, 80600 N, 80600 P, 80600 AC, 80600 AD -----	20
B80201	Cloth Plate, for styles in Class 80200 (screw No. 22574) -----	27
B80201 A	Cloth Plate Swinging Extension, for Styles 80200 AA, 80200 AB (screw No. 89) -----	27
B80201 E	Cloth Plate Swinging Extension, for Style 80200 AC (screw No. 89) -----	27
80205	Feed Dog, for styles in Class 80200 (screw No. 93) --	12
80220	Presser Foot Assembly, right, for styles in Class 80200; one each Nos. 80220 B, HA65 E, 907, 22525 C, 80220 C; two No. 88 A -----	11
80220 A	Presser Foot Assembly, left, for styles in Class 80200, also for Style 81200 H; one each Nos. HA65 L, 80220 D, 80620 E; two No. 88 A -----	11
80220 B	Presser Foot Bottom, right, for styles in Class 80200 (hinge screw No. HA65 E) -----	11
80220 C	Presser Foot Shank, right, for styles in Classes 80200, 81200 (set screw No. 88 A, clamp screw No. 22525 C, clamp screw locknut No. 907) -----	11
80220 D	Presser Foot Bottom, left, for styles in Class 80200, also for Style 81200 H (hinge screw No. HA65 L) ---	11
80222	Main Shaft, for styles in Class 80200 -----	23

LIST OF PARTS

Symbol to Order By	The figures in the last column refer only to the plates illustrating the parts and are not to be used in ordering. Prices furnished on application.	Plate No.
80224	Throat Plate, for styles in Class 80200 (screw No. 22526)-----	12
80225	Feed Bar Needle Guard, for styles in Classes 80200, 81200; marked "TD" (screw No. 93 A)-----	1
80230	Tape Cutter Driving Eccentric Connecting Rod, for Style 80600 H (nut, left thread, No. 15430 C; nut, right thread, No. 15430 D) -----	8
80233	Feed Rocker, for styles in Classes 80200, 81200 (set screw No. 89)-----	22
80234 B	Feed Bar, for styles in Classes 80200, 81200 (set screw No. 89)-----	22
‡80236	Looper Drive Eccentric Connecting Bearing, marked "TA", for styles in Classes 80200, 81200 (screw No. 88 F)-----	14
80237	Tape Cutter Upper Knife Lever Spring, for Style 80600 H-----	10
80238	Tape Cutter Upper Knife Operating Ratchet Block Spring, for Style 80600 H (screw No. 57 WD) -----	10
80239	Looper Rocker Shaft, for styles in Class 80200 -----	15
80239 C	Looper Rocker Shaft Bushing, left, 1 5/64 inches long, for styles in Class 80200-----	7
80239 D	Looper Rocker Shaft Bushing, right, 7/8 inch long, for styles in Class 80200 -----	7
80246	Needle Lever Shaft Bushing, for styles in Classes 80200, 81200 (screw No. 89)-----	7
80250	Frame Needle Thread Rolling Thread Guide Assembly, for styles in Classes 80200, 81200; also for Styles 80600 E, 80600 H, 80600 J, 80600 M, 80600 N, 80600 P, 80600 AC, 80600 AD; one each Nos. HS52 B, 88, 22743, 80250 A, 80250 B, 80668 (screw No. 95)--	17
80250 A	Frame Needle Thread Rolling Thread Guide Support--	17
80250 B	Frame Needle Thread Rolling Thread Guide (screw No. 22743)-----	2
80266	Washer, for tape cutter upper knife operating ratchet block stop screw on Style 80600 H -----	6
80267	Hand Lifter, for styles in Classes 80200, 81200 (screw No. 11639 H)-----	17
80268	Tape Cutter Upper Knife Actuating Lever Spring Stop Pin, for Style 80600 H-----	6
80269	Tape Cutter Upper Knife Lever Stop Screw Block, for Style 80600 H (screw No. 93 A) -----	9
80270	Tape Cutter Upper Knife Operating Lever Buffer, for Style 80600 H-----	6
80271	Tape Cutter Upper Knife Lever, for Style 80600 H (screw, fillister head, No. 94, screw, headless, No. 22764)-----	19
80272	Tape Cutter Upper Knife Clamp, for Style 80600 H (screw No. 22517) -----	8
80274	Tape Cutter Support, for Style 80600 H (screw No. 22806 G)-----	18
‡ See Page 8		

LIST OF PARTS

Symbol to Order By	The figures in the last column refer only to the plates illustrating the parts and are not to be used in ordering. Prices furnished on application.	Plate No.
80275	Tape Cutter Lower Knife, for Style 80600 H (screw No. 99248, washer No. 8372 A) -----	8
80276	Tape Cutter Upper Knife Operating Lever, for Style 80600 H-----	19
80277	Tape Cutter Upper Knife, for Style 80600 H (height adjusting screw No. 93) -----	8
80278	Tape Cutter Upper Knife Operating Lever Shaft, for Style 80600 H (set screw No. 88) -----	15
80279	Tape Cutter Upper Knife Actuating Lever Shaft-----	15
80280 A	Base Plate, for styles in Classes 80200, 81200 (attaching bolt No. 650-24) -----	27
80281 A	Tape Cutter Upper Knife Actuating Lever, for Style 80600 H (stop screw No. 906 A, locknut No. 907)---	19
80283	Tape Cutter Upper Knife Actuating Ratchet Block Adjusting Screw Stop, for Style 80600 H-----	6
80284	Looper Thread Guard, for styles in Class 80200 (screw No. 94) -----	18
80284 H	Looper Thread Guard, for Style 80600 H (screw No. 94)-----	18
80285	Tape Cutter Upper Knife Lever Adjusting Screw Stop, for Style 80600 H -----	6
80286 A	Tape Cutter Upper Knife Operating Pawl, for Style 80600 H (attaching screw No. 93, dowel pin No. 76099 G)-----	19
80287	Tape Cutter Upper Knife Operating Ratchet Block, for Style 80600 H (stop screw No. 906, stop screw washer No. 80266)-----	8
80288 A	Tape Cutter Upper Knife Actuating Pawl, for Style 80600 H (screw No. 22768) -----	9
80288 B	Tape Cutter Upper Knife Actuating Pawl Trip Lever, for Style 80600 H (screw No. 22557) -----	9
80288 C	Tape Cutter Upper Knife Actuating Pawl Trip Lever Shoe, for Style 80600 H (screw No. 22564)-----	8
80288 D	Tape Cutter Upper Knife Actuating Pawl Trip Lever Spring, for Style 80600 H (screw No. 22760 A)-----	10
80288 F	Tape Cutter Upper Knife Actuating Pawl Trip Dog Cam, for Style 80600 H (screw No. 94)-----	1
80288 G	Tape Cutter Upper Knife Actuating Pawl Trip Dog Spring, for Style 80600 H (screw No. 22599)-----	10
80288 H	Tape Cutter Upper Knife Actuating Pawl Trip Dog, for Style 80600 H (screw No. 22559 B)-----	8
80289	Cloth Plate Oil Hole Insert, for styles in Classes 80200, 81200; also for No. 81255-----	2
80290 B	Cloth Plate Oil Reservoir Glass Housing, for styles in Class 81200 -----	20
80290 E	Cloth Plate Oil Reservoir Assembly, for styles in Class 80200; one each Nos. 666-8 A, 80290 F, 80290 G (screw No. 22562) -----	20
‡80290 F	Cloth Plate Oil Reservoir, for styles in Class 80200--	20

‡ See Page 8

LIST OF PARTS

Symbol to Order By	The figures in the last column refer only to the plates illustrating the parts and are not to be used in ordering. Prices furnished on application.	Plate No.
80290 G	Cloth Plate Oil Reservoir Cover, for styles in Class 80200-----	20
80291	Feed Driving Eccentric Connecting Oil Tube Clamp, on styles in Classes 80200, 81200 (screw No. 22513)-	8
80292 A	Feed Rocker Shaft Bushing, for styles in Classes 80200, 81200 -----	7
‡80293	Needle Lever Connecting Rod Bearing Oil Reservoir, for styles in Classes 80200, 81200 of German manufacture only (set screw No. 95, spot screw No. 96 A)-----	20
‡80293 A	Needle Lever Connecting Rod Bearing Oil Reservoir, for styles in Classes 80200, 81200 of American manufacture only (set screw No. 95, spot screw No. 96 A)-----	20
80297 D	Tape Cutter Upper Knife Actuating Shoe, for Style 80600 H (screw No. 97)-----	1
80408 A	Feed Rocker Shaft, .407 inch diameter, for styles in Class 80600 (screw No. 22706 A)-----	16
80411	Feed Bar Shaft, .407 inch diameter, for styles in Class 80600 (screw No. 22706 A)-----	16
80437 A	Cloth Plate Swinging Extension Hinge Pin, for styles in Classes 80200, 81200 -----	15
80438	Cloth Plate Swinging Extension Locking Bolt Spring--	10
80440	Cloth Plate Swinging Extension Locking Bolt Knob ---	5
B80601 E	Cloth Plate, for Styles 80600 E, 80600 F, 80600 J, 80600 M, 80600 N, 80600 P, 80600 AC, 80600 AD (screw No. 22574) -----	24
B80601 H	Cloth Plate, for Style 80600 H (screw No. 22574)----	27
B80601 I	Cloth Plate Swinging Extension, for Style 80600 H (screw No. 89) -----	27
B80601 P	Cloth Plate Swinging Extension, for Styles 80600 E, 80600 F, 80600 N, 80600 P (screw No. 89) -----	24
80604	Looper Thread Cast-off, for styles in Classes 80200, 80600 (screw No. AS22 D) -----	17
80605 D	Feed Dog, for Styles 80600 J, 80600 M, 80600 AC, 80600 AD (screw No. 93)-----	12
80605 E	Feed Dog, for Styles 80600 E, 80600 N, 80600 P (screw No. 93) -----	12
80605 H	Feed Dog, for Style 80600 H (screw No. 22874 C) ---	12
80606 B	Feed Lift Cam, for Styles 80600 E, 80600 F, 80600 J, 80600 M, 80600 N, 80600 P, 80600 AC, 80600 AD (screw No. 22894 D) -----	9
80608 A	Looper, for Styles 80200 AB, 80600 F, 80600 AD (screw No. 73) -----	1
80613 A	Looper Rocker, for styles in Classes 80200, 80600--	14
80615	Needle Lever (spot screw No. 81, set screw No. 95)--	22
80617	Needle Bar (needle clamp nut No. HA56) -----	16
80620 E	Presser Foot Shank, for styles in Classes 80200, 81200 (set screw, fillister head, No. 88 A)-----	12
‡ See Page 8		

LIST OF PARTS

Symbol to Order By	The figures in the last column refer only to the plates illustrating the parts and are not to be used in ordering. Prices furnished on application.	Plate No.
80620 Q	Presser Foot Assembly, for Styles 80600 J, 80600 M, 80600 AC, 80600 AD; one each Nos. 22840 A, 51430 F, 80620 R, 80620 S, 92131; two No. 88 A, 12934 A, 22560 A-----	11
80620 R	Presser Foot Bottom, for Styles 80600 J, 80600 M, 80600 AC, 80600 AD (hinge screw No. 92131)-----	11
80620 S	Presser Foot Shank, for Styles 80600 J, 80600 M, 80600 AC, 80600 AD (set screw No. 88 A, adjusting screw, No. 22560 A, adjusting screw locknut, No. 12934 A)-----	11
80621 A	Pulley Hub (key No. HA66 K, lock washer No. 80674, screw No. 80-----	13
B80621 B	Pulley Rim, grooved for round belt, working diameter of belt groove 4 1/4 inches, for Styles 80600 E, 80600 F, 80600 J, 80600 M, 80600 AC, 80600 AD (screw No. 80)-----	24
B80621 H	Pulley Rim, grooved for round belt, working diameter of belt groove 6 inches, for styles in Classes 80200, 81200; also for Style 80600 H (screw No. 80)-----	24
80622	Main Shaft, for Styles 80600 E, 80600 F, 80600 J, 80600 M, 80600 N, 80600 P, 80600 AC, 80600 AD--	23
80622 H	Main Shaft, for Style 80600 H-----	23
80623	Looper Thread Take-up, for styles in Classes 80200, 80600 (screw No. J79 J)-----	17
80624 D	Throat Plate, for Styles 80600 J, 80600 M, 80600 AC, 80600 AD (screw No. 80)-----	12
80624 E	Throat Plate, for Styles 80600 E, 80600 N, 80600 P (screw No. 80)-----	12
80625	Feed Bar Needle Guard, for Styles 80600 E, 80600 F, 80600 J, 80600 M, 80600 N, 80600 P, 80600 AC, 80600 AD (screw No. HA95)-----	1
80625 H	Feed Bar Needle Guard, for Styles 80600 H (screw No. 22874 C)-----	1
80626 E	Feed Dog, for Style 80600 F (screw No. 22596)-----	12
80627 E	Presser Foot, for Styles 80600 E, 80600 F, 80600 N, 80600 P; one each Nos. C41, 88, 907, 22570, 22707, 80627 EA, 80627 EB; two each Nos. 12934 A, 22560 B-----	11
80627 K	Presser Foot Shank, for Style 80600 H (set screw No. 88 A, adjusting screw, front, No. 22560 A, adjusting screw, rear, No. 22560 B, adjusting screw locknut No. 12934 A, stop screw No. 531, stop screw locknut No. 12934 A)-----	11
80627 L	Presser Foot Bottom, for Style 80600 H (hinge screw No. 99251)-----	11
80627 M	Presser Foot Assembly, for Style 80600 H; one each Nos. 531, 22560 A, 22560 B, 80627 K, 80627 L, 99251; two No. 88 A; three No. 12934 A-----	11
80627 EA	Presser Foot Shank, for Style 80600 E, 80600 F----	--
80627 EB	Presser Foot Bottom, for Style 80600 E, 80600 F---	--
80628 E	Throat Plate, for Style 80600 F (screw No. 80)-----	12

LIST OF PARTS

Symbol to Order By	The figures in the last column refer only to the plates illustrating the parts and are not to be used in ordering. Prices furnished on application.	Plate No.
80628 H	Throat Plate, for Style 80600 H (screw No. 80) -----	12
80630	Needle Lever Connecting Rod Tube (nut, left thread, No. 80630 C, nut, right thread No. 80630 D)-----	16
80630 C	Needle Lever Connecting Rod Tube Nut, left thread--	6
80630 D	Needle Lever Connecting Rod Tube Nut, right thread--	6
80631	Presser Bar Lifter Guide Plate (screw No. 94) -----	8
80632	Presser Bar Lifter (screws Nos. 95, 22870)-----	19
80633 H	Feed Rocker, for styles in Class 80600 (screw No. 89)-	22
80634 C	Feed Bar, for Styles 80600 E, 80600 F, 80600 J, 80600 M, 80600 N, 80600 P, 80600 AC, 80600 AD (screw No. 89) -----	22
80634 E	Feed Driving Eccentric Fork, for styles in Class 80600 (screw No. 93 A)-----	19
80634 H	Feed Bar, for Style 80600 H (set screw No. 89)-----	18
80634 EB	Felt, for No. 80634 E, on styles in Class 80600-----	28
‡80636	Looper Drive Eccentric Connection Bearing, marked "TB", for styles in Class 80600 (screw No. 88 F)--	14
80636 A	Needle Lever and Looper Lever Ball Stud Fork (screw No. 22729; or 22515 A for 29442 L, 29442 N)-----	8
80637	Looper Drive Lever, for styles in Classes 80200, 80600 (screw No. 22517)-----	13
80638 A	Looper Drive Lever Shaft Rocker (spot screw No. 96, clamp screw No. 136)-----	13
80639	Looper Rocker Shaft, for styles in Class 80600 -----	15
80639 C	Looper Rocker Shaft Bushing, 1 5/64 inches long, for styles in Class 80600-----	7
80639 D	Looper Rocker Shaft Bushing, 7/8 inch long, for styles in Class 80600-----	7
80640	Looper Drive Lever Rocker Shaft, for styles in Classes 80200, 80600 -----	16
80640 D	Looper Drive Lever Shaft Bushing, 1 19/32 inches long, for styles in Classes 80200, 80600 -----	7
80642	Looper Drive Eccentric (spot screw No. 22894 L, set screw No. 22894 C)-----	13
80643	Needle Lever Shaft-----	15
80644	Needle Lever Shaft Hole Plug Screw (set screw No. 88)-	5
80645	Looper Drive Eccentric Connection Ball Stud (nut No. 80691)-----	9
80646	Needle Lever Shaft Bushing, right, for styles in Class 80600 (screw No. 89)-----	7
80647	Needle Lever Shaft Bushing, left, for styles in Class 80600 (screw No. 89)-----	7
80648	Lifter Lever (stud No. 420)-----	24
80649	Lifter Lever Spring-----	10
80650	Needle Lever Connection Bearing, upper (screw No. 22587)-----	14
80651	Feed Driving Eccentric Connection (screw No. 22587)-	14
80652	Needle Lever Connection Bearing, lower (screw No. 22587)-----	14
‡ See Page 8		

LIST OF PARTS

Symbol to Order By	The figures in the last column refer only to the plates illustrating the parts and are not to be used in ordering. Prices furnished on application.	Plate No.
80653	Looper Thread Cast-off Support, for styles in Class 80200; also for Styles 80600 E, 80600 F, 80600 J, 80600 M, 80600 N, 80600 P, 80600 AC, 80600 AD (screw No. HA61 D)-----	17
80653 A	Looper Thread Cast-off Assembly, for styles in Class 80200; also for Styles 80600 E, 80600 F, 80600 J, 80600 M, 80600 N, 80600 P, 80600 AC, 80600 AD; one each Nos. 80604, 80653; two each Nos. AS22 D, HA102, 22743 -----	17
80653 H	Looper Thread Cast-off Support, for Style 80600 H (screw No. HA61 D)-----	17
80653 I	Looper Thread Cast-off Assembly, for Style 80600 H; one each Nos. 80604, 80653 H; two each Nos. AS22 D, HA102 A, 22743 -----	17
80654	Stitch Regulating Stud Bushing, for styles in Classes 80200, 81200; also for Styles 80600 E, 80600 F, 80600 J, 80600 M, 80600 N, 80600 P, 80600 AC, 80600 AD -----	8
80654 H	Stitch Regulating Stud Bushing, for Style 80600 H----	8
80655	Needle Bar Connection Thread Guide Pin-----	8
80656	Needle Lever Ball (clamp screw No. BP108)-----	9
‡80657 A	Looper Rocker Connecting Rod Ball Joint, left, for styles in Classes 80200, 80600 (screw No. 22729 C, ball stud nut No. 12538) -----	9
‡80658 A	Looper Rocker Connecting Rod Ball Joint, right, for styles in Class 80600 (nut No. 18) -----	9
80659	Needle Bar Connection (clamp screw No. BP108)----	17
80660	Presser Bar, left, for styles in Classes 80200, 81200	16
80661	Presser Bar, right, for styles in Classes 80200, 81200; also front presser bar for Styles 80600 E, 80600 F, 80600 H, 80600 N, 80600 P, 80600 AC, 80600 AD; rear presser bar on Styles 80600 E, 80600 F, 80600 N, 80600 P -----	16
80661 A	Presser Bar, rear, for Style 80600 H, 80600 AC, 80600 AD -----	16
80662	Presser Bar Bushing, front, for styles in Classes 80200, 80600, 81200 -----	7
80662 A	Presser Bar Bushing, rear, for styles in Classes 80200, 80600, 81200 -----	7
80663	Presser Spring, upper -----	15
80664	Presser Spring, lower -----	15
80665	Needle Thread Take-up Rolling Thread Guide Support, for styles in Classes 80200, 81200-----	17
80665 A	Needle Thread Take-up Rolling Thread Guide Assembly, for styles in Class 80600; one each Nos. HS53 B, 88, 80665 B, 80668 (screw No. 95) -----	17
80665 B	Needle Thread Take-up Rolling Thread Guide Support, for styles in Class 80600 -----	17

‡ See Page 8

LIST OF PARTS

Symbol to Order By	The figures in the last column refer only to the plates illustrating the parts and are not to be used in ordering. Prices furnished on application.	Plate No.
80665 C	Filter Cord Guide, attaches to needle thread take-up rolling thread guide support, for Styles 80600 E, 80600 F, 80600 H, 80600 N, 80600 P (screw No. 88)-	17
80665 D	Needle Thread Take-up Rolling Thread Guide Assem- bly, for styles in Classes 80200, 81200; one each Nos. HS53 B, 88, 80665, 80668 (screw No. 95) ----	17
80665 E	Needle Thread Nipper Support Pin, for Style 80600 F-	28
80665 F	Needle Thread Nipper Support Disc, for Style 80600 F-----	28
80667	Presser Spring Pin; also tension disc stop pin-----	8
80668	Needle Thread Take-up Rolling Thread Guide Roller; also for No. 80250-----	2
80669	Needle Bar Connection Tension Post Ferrule, front; also for No. 81250 G-----	2
80670	Chain Cutter Knife Bar Ball Stud Washer, for Styles 80600 E, 80600 F, 80600 J, 80600 M, 80600 N, 80600 P, 80600 AC, 80600 AD-----	6
80671	Chain Cutter Knife Bar, for Styles 80600 E, 80600 F, 80600 J, 80600 M, 80600 N, 80600 P, 80600 AC, 80600 AD (screw No. 98) -----	19
80672	Chain Cutter Knife Driving Eccentric, for Styles 80600 E, 80600 F, 80600 J, 80600 M, 80600 N, 80600 P, 80600 AC, 80600 AD (spot screw No. 96)--	13
80673 A	Needle Bar Bushing, rear, for styles in Classes 80200, 80600, 81200 -----	7
80673 B	Needle Bar Bushing, front, for styles in Classes 80200, 80600, 81200 -----	7
80673 C	Needle Bar Guard, for styles in Class 80600-----	15
80674	Pulley Hub Lock Washer (screw No. 80)-----	6
80675	Chain Cutter Stationary Knife, for Styles 80600 E, 80600 F, 80600 J, 80600 M, 80600 N, 80600 P, 80600 AC, 80600 AD (screw No. 88 D) -----	8
80676	Tension Disc, 63/64 inch diameter -----	2
80676 A	Tension Disc, 1 7/32 inches diameter -----	2
80677	Chain Cutter Driven Knife, for Styles 80600 E, 80600 F, 80600 J, 80600 M, 80600 N, 80600 P, 80600 AC, 80600 AD (screw No. 92127) -----	8
80678	Gasket, leather, for main oil reservoir oil cup elbow on styles in Class 80600 -----	6
80678 A	Gasket, leather, for oil cup No. 80682 on styles in Class 80600-----	6
80680	Looper Avoid Eccentric Fork Assembly, for styles in Classes 80200, 80600; one each Nos. 85, 318, 80680 A, 80680 C; two each Nos. 94, 80680 B-----	13
80680 A	Looper Avoid Eccentric Fork, for styles in Classes 80200, 80600 (clamp screw No. 318, adjusting screw No. 85)-----	13
80680 B	Looper Avoid Eccentric Fork Shoe, for styles in Classes 80200, 80600 (screw No. 94) -----	9
80680 C	Looper Avoid Eccentric Sponge, for styles in Classes 80200, 80600 -----	19

LIST OF PARTS

Symbol to Order By	The figures in the last column refer only to the plates illustrating the parts and are not to be used in ordering. Prices furnished on application.	Plate No.
80681	Main Shaft Collar (screw No. 74 E)-----	2
80682 B	Gasket, leather, for oiler No. 80682-----	6
80683	End Cover, for Styles 80600 E, 80600 F, 80600 J, 80600 M, 80600 N, 80600 P, 80600 AC, 80600 AD (pivot stud No. 92121, spring washer No. 12957 E)--	22
80683 H	End Cover, for Style 80600 H (pivot stud No. 92121, spring washer No. 12957 E) -----	22
80684	Looper Thread Guard, for Styles 80600 E, 80600 F, 80600 J, 80600 M, 80600 N, 80600 P, 80600 AC, 80600 AD (screw No. 94) -----	18
80685	Main Shaft Bushing and Housing, for right main shaft bearing (bushing No. 80694 C, set screw No. HA95, spot screw No. HA81)-----	18
B80687	Face Plate (screw No. 376)-----	24
B80688	Top Cover -----	24
80689 A	Oil Cup, .192 inch diameter shank, for needle lever shaft bearings and looper drive lever rocker shaft bearings; also for left main shaft bearing on styles in Class 80200; and presser bar, needle bar, left main shaft and looper rocker shaft bearing on styles in Class 80600-----	2
80690 A	Oil Cup, .276 inch diameter shank, for right main shaft bearings-----	2
80691	Looper Drive Eccentric Connection Ball Stud Nut----	6
80692 B	Chain Cutter Knife Bar Shaft Bushing, for Styles 80600 E, 80600 F, 80600 J, 80600 M, 80600 N, 80600 P, 80600 AC, 80600 AD -----	7
80692 C	Feed Rocker Shaft Bushing, for styles in Class 80600-	7
†80693	Needle Lever Connecting Rod Bearing Oil Reservoir, for styles in Class 80600 (screw No. 81, spot screw No. 96 A)-----	20
80694 B	Main Shaft Bushing, left and middle-----	7
80694 C	Main Shaft Bushing, right-----	7
80695 A	Feed Driving Eccentric, stitch range 2 1/2 to 4 per inch, for styles in Class 80600 (screw No. 22894 K)-	9
80696	Stitch Regulating Stud, for styles in Class 80200, 81200; also for Styles 80600 E, 80600 F, 80600 J, 80600 M, 80600 N, 80600 P, 80600 AC, 80600 AD (nut No. HA18 A, washer No. HA20 A, stop screw No. T26)--	5
80696 H	Stitch Regulator Stud, for Style 80600 H (nut No. HA18 A, washer No. HA20 A, stop screw No. T26)--	5
B80697	Tape Cutter Housing, for Style 80600 H (screw No. 93 A)-----	24
80698	Oil Cup Elbow, for use with oil cup No. 80682 -----	20
80698 A	Needle Thread Lubricator, for Styles 80600 E, 80600 F, 80600 J, 80600 M, 80600 N, 80600 P, 80600 AC, 80600 AD (screw No. 79048, washer No. 69 H, lubricating felt No. 80199 K) -----	20
80698 B	Oil Cup Elbow, for use with oil cup No. 80693 on styles in Class 80600-----	20

† See Page 8

LIST OF PARTS

Symbol to Order By	The figures in the last column refer only to the plates illustrating the parts and are not to be used in ordering. Prices furnished on application.	Plate No.
80699 A	Dowel Pin, for upper section of bed on machines of German manufacture only-----	8
80699 B	Feed Bar Needle Guard Stop Pin, for Styles 80600 E, 80600 F, 80600 J, 80600 M, 80600 N, 80600 P, 80600 AC, 80600 AD -----	8
81086 C	Frame Rolling Thread Guide Axle (screw No, 88) ---	8
81086 G	Needle Thread Take-up Rolling Thread Guide Axle (screw No, 88) -----	8
81093	Frame Rolling Thread Guide Roller-----	2
B81201	Cloth Plate, for styles in Class 81200 (screw No. 22574)-----	27
B81201 A	Cloth Plate Swinging Extension, for styles in Class 81200 (screw No. 89)-----	27
81203	Cloth Plate Edge Guide, for styles in Class 81200 (screw No. 22514) -----	12
81203 B	Fabric Edge Guide, front, for Style 81200 A (screw No. 376 A)-----	1
81203 C	Cloth Plate Edge Guide Tongue, marked "TC" for Style 81200 A (screw No. HS24 C) -----	1
81205 A	Feed Dog, for styles in Class 81200 (screw No. 93)--	12
81207	Spreader Assembly, for styles in Class 81200; one each Nos. 22 KH, 81208 A, 81210 (set screw No. 73 X)--	1
81208	Looper, for styles in Class 81200 (screw No. 73 X)--	1
81208 A	Looper Spreader, for styles in Class 81200-----	1
81210	Loop Retainer, for styles in Class 81200 (screw No. 22 KH)-----	1
81211	Thread Retainer, for Style 81200 A (screw No. 90)---	1
81213	Looper Rocker, for styles in Class 81200 (screw No. 95)-----	13
81213 A	Spreader Rocker, for styles in Class 81200 (screw No. 98)-----	13
81220	Presser Foot Assembly, right, for Style 81200 H; one each Nos. HA65 E, 907, 22525 C, 80220 C; 81220 B, two No. 88 B -----	11
81220 A	Presser Foot Assembly, right, for Style 81200 A; one each Nos. 22513, 81220, 81297 -----	11
81220 B	Presser Foot Bottom, for styles in Class 81200 (hinge screw HA65 E) -----	11
81220 C	Presser Foot Bottom, left, for Style 81200 A (hinge screw No. HA65 L) -----	11
81220 D	Presser Foot Assembly, left, for Style 81200 A; one each Nos. HA65 L, 80620 E, 81220 C; two No. 88 A)-----	11
81222	Main Shaft, for styles in Class 81200 -----	23
81224 I	Throat Plate, for Style 81200 A (screw No. 22526)---	12
81225	Throat Plate Needle Guard, marked "GO", for styles in Class 81200 (screw No. 90)-----	1
81237	Looper Driving Lever, for styles in Class 81200 ----	22
81238	Spreader Driving Lever, for styles in Class 81200 (clamp screw No. 22517) -----	19
81239	Cloth Plate Swinging Extension Locking Bolt (spring No. 80438, bolt knob No. 80440)-----	8

LIST OF PARTS

Symbol to Order By	The figures in the last column refer only to the plates illustrating the parts and are not to be used in ordering. Prices furnished on application.	Plate No.
81240	Looper and Spreader Driving Lever Shaft, for styles in Class 81200-----	16
81240 C	Looper and Spreader Driving Lever Shaft Bushing, for styles in Class 81200-----	7
81250 E	Frame Looper Thread Tension Bracket, for Style 81200 A (screw No. 22517) -----	17
81250 G	Frame Looper Thread Tension Assembly, for Style 81200 A; one each Nos. 28 C, 107, 108, 1349 A-5, 80669, 81250 E, 81253, 81292; two each Nos. HS100 D, 80676 A (screw No. 22517)-----	17
81251 A	Spreader Rocker Shaft, for styles in Class 81200----	15
81252	Frame Looper Thread Guide, for styles in Class 81200 (screw No. 22560 B)-----	2
81253	Frame Looper Thread Tension Thread Guide, for styles in Class 81200 (screw No. 28 C)-----	2
81255	Spreader Rocker Shaft Bearing, for styles in Class 81200 (screw No. 318, washer No. 81257)-----	13
81256	Frame Thread Eyelet, 1 3/16 inches long (screw No. 28 C)-----	2
81256 A	Frame Thread Eyelet Assembly; one each Nos. 28 C, AS137, 81256 (screw No. 22560 B)-----	2
81257	Spreader Rocker Shaft Bearing Attaching Screw Washer, for styles in Class 81200-----	6
81260	Looper Rocker Cone Stud, for styles in Class 81200 (nut No. 12987 A)-----	15
81261	Looper Rocker Cone Stud Bushing, for styles in Class 81200-----	15
81284	Looper Thread Guard, for styles in Class 81200 (screw No. 94) -----	18
81290	Cloth Plate Oil Reservoir Assembly, for styles in Class 81200; one each Nos. 666-8 A, 666-8 D, 666- 8 E, 80290 B, 81290 A (screw No. 22562) -----	20
†81290 A	Cloth Plate Oil Reservoir, for styles in Class 81200-	20
81292	Looper Thread Tension Post, for styles in Class 81200-	10
81297	Presser Foot Tongue, marked "MP", for Style 81200 A (screw No. 22513) -----	1
92121	Pivot Stud, for end cover on styles in Class 80600---	4
92127	Screw, for chain cutter driven knife on Styles 80600 E, 80600 F, 80600 J, 80600 M, 80600 N, 80600 P, 80600 AC, 80600 AD -----	4
92131	Hinge Screw, for presser foot bottom on Styles 80600 J, 80600 M, 80600 AC, 80600 AD -----	4
99246	Stop Screw, for tape cutter upper knife actuating lever spring on Style 80600 H (locknut No. 907)-----	5
99248	Screw, for tape cutter lower knife on Style 80600 H--	4
99251	Hinge Screw, for presser foot bottom on Style 80600 H-	5
99256	Screw, rear, for attaching upper section of frame to lower section-----	4
† See Page 8		

UNION SPECIAL CLASS 21800 TABLE TYPE BAG CLOSERS

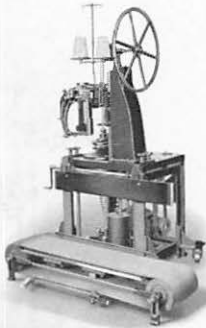

STYLE 21800 C

FOR ALL TYPES OF BAGS

(Above) Widely used for closing cotton, burlap and paper bags. Designed for mounting Class 14500 and 80600 sewing heads. Dual drive mechanism for independent or synchronized conveyor belt travel. Standard machine includes conveyor 12 inches wide by 4 foot long. Longer conveyors available if required. Both sewing head and conveyor controlled by single pedal. Sewing head and conveyor adjustable vertically. Floor space: 56" wide by 48½" deep with 12" conveyor. Height 67."

THESE machines consist of a portable base with mounting stand and bracket for the sewing head, power driven conveyor and certain adjustment features for raising and lowering the conveyor and the sewing head.

Class 21800 machines are ideal all-around machines for regular plant production. They are the most widely known and used bag closing machines in the world because of their adaptability for closing all types and sizes of bags, and their excellent performance under all kinds of operating conditions. Two general types of machines are available in this class: one which permits vertical adjustment of the sewing head and one which has a fixed mounting for the head. Conveyors on all machines in this group are adjustable to compensate for bags of varying height.

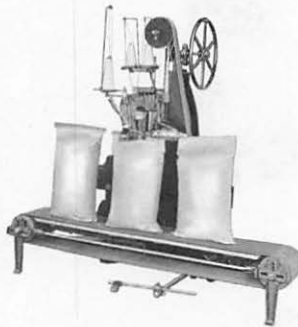

STYLE 21800 H

TAPE-BOUND PAPER BAG CLOSURE

(Above) Another unit designed for a specific job—the fast, economical closing of paper bags with a paper tape binding. It is equipped with a five foot conveyor for easy handling of paper bags at the loading end. A Style 80600 H sewing head is used. Both conveyor and sewing head are adjustable vertically. Floor space 68" wide by 48½" deep. Height 67."

STYLE 21800 N

FOR SMALL PAPER BAGS—PORTABLE

(Below) This machine is a portable table-type unit designed for use with the Style 60000 D sewing head which produces the Dabl-Tape Closure on small paper bags. It includes a power-driven conveyor which is adjustable vertically to accommodate different size bags. Conveyor is 8 inches wide by 4 feet long and is synchronized with the speed of the sewing head. Control is by floor treadle and the unit may be operated from a sitting position. Floor space is 54" by 43". Height 72".

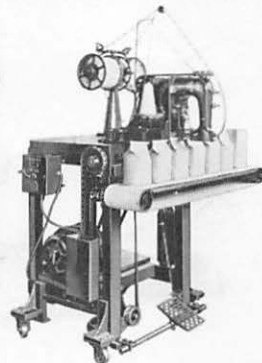

UNION SPECIAL COLUMN TYPE BAG CLOSERS

UNION SPECIAL column type machines consist of a column and base, mounting brackets for the sewing head and motor, and are available in styles with or without conveyor. Certain styles provide vertical adjustment features for the sewing head or the conveyor.

Column type machines are available in both portable and fixed base models for use with any one of the Union Special sewing heads. Thus, complete units can be supplied to provide the desired type of closure on any size or type of bag.

STYLE 20100 H

FIXED BASE

(Right) This machine is designed for use with a conveyor already installed or to be ordered separately. Sewing head is driven independently of conveyor and is controlled by a pedal. Generally used with conveyors which are run continuously, it makes an ideal high production unit. May be equipped with Class 14500 or Class 80600 sewing head as required.

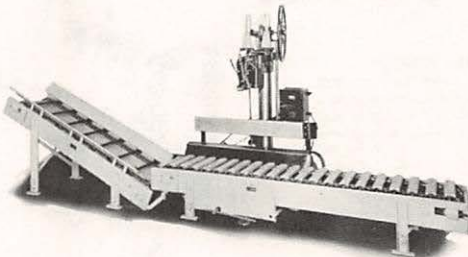
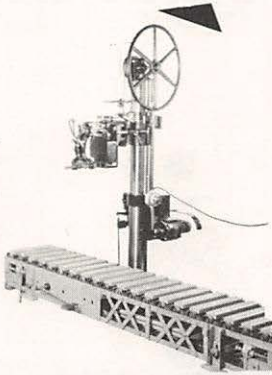

STYLE 20100 D

FLOATING BAG CARRIER—PORTABLE

(Above) An ideal machine for use in smaller plants, and for utility duty in larger plants. Uses Class 14500 sewing head, and is equipped with floating bag carrier which returns automatically to its loading position when closed bag is removed. Carrier and sewing head are both adjustable vertically. Complete portability makes bag closing in different sections of the plant practical and efficient.

Style 20100 E uses Class 80600 sewing head and has same features as Style 20100 D. Floor space: 42" by 34". Height 69".

CLASS 20500

FOR HEAVY DUTY, HIGH PRODUCTION

(Left) Heavy duty, high production units for medium and heavy weight bags. Adjustable sewing head mounting for different size bags. Available with power-driven horizontal conveyor, inclined conveyor, or both; or with conveyor transmission unit only, for plant production line. Three control systems to choose from, including single-pedal control of both conveyor drive and sewing head. Floor space with 8-foot horizontal conveyors: 108" wide by 45" deep.